

## **Historic, Archive Document**

Do not assume content reflects current scientific knowledge, policies, or practices.



3857

**MUZZY BROTHERS**  
**SEEDS and IMPLEMENTS**  
**POULTRY SUPPLIES**  
ESTABLISHED 1835

**1920**

**PATERSON, N. J.**

# SPECIAL NOTICE

---



WE make a specialty of supplying the best strains of seeds that can be produced. We are always on the alert for a better strain, and if we find it we spare no expense in securing seed stock of it.

Owing to the war it is impossible to procure many varieties of seeds. Foreign and domestic seed crops were all exceedingly light this season, especially peas and beans which were almost total failure. It will be well therefore to state when ordering whether we are at liberty to substitute or not. Customers can depend upon our using our best judgment in substituting other equally good sorts for those orders which we may not be able to supply.

## TERMS OF GUARANTEE

The seeds offered in this catalogue have been carefully grown, selected, cleaned and tested for germination, and we believe them to be first class in every respect, but we cannot guarantee the crop as too many conditions enter into it, therefore we give no warranty, expressed or implied, as to description, purity, productiveness, or any other matter of any seeds, bulbs or plants we send out, and we will not be in any way responsible for the crop. If the purchaser does not accept the goods on these terms they are to be returned at once, and if the money has been paid for them it will be refunded.

MUZZY BROS.

1835 - 1920

# Muzzy Brothers



IN presenting this revised edition of our Illustrated General Catalogue, we wish to thank our customers for their liberal past patronage and take pleasure in soliciting their further valued orders.

This is our 85th Annual Catalogue. It contains lists of the very choice seeds, bulbs, roots and some other things that we have to offer for 1920. You can make up your order from its pages with entire confidence in the exceptional quality of the products we are offering.

Our catalogues have always received a considerable amount of study. The cultural directions and descriptions in them are concise and to the point.

A house that, during the eighty-five years it has been in business, has clung firmly to its original idea of supplying seeds of the highest grade only, gaining thereby the confidence and loyal friendship of a steadily increasing number of both amateur and professional gardeners.

Years of research have been devoted to seeds, and we have eliminated quite a number of once well-known varieties that have been superseded by incomparably better sorts. If you had your mind set upon buying one particular kind of corn, for instance, and fail to find it listed herein, you may rest assured that something far better has taken its place.

We would suggest that your order be made up as soon after the receipt of this catalogue as possible. It will help us to ship promptly, and it will help you by giving you your goods just when you want them. Placing orders late sometimes makes delays unavoidable. But we have the facilities for handling a vast amount of business, and your orders will receive the promptest attention regardless of when they come.

If there is any information you want that is not given in this catalogue, write us about it. We will give all inquiries our careful attention.

May we have the pleasure of filling your order?

# *Selected Varieties and Novelties in Vegetables*

## AUSTRALIAN BROWN ONION

There are a number of reasons why our strain is bringing a premium this season, a few of which are:

*Pedigreed Australian Brown..*

- Is a heavy cropper.
- Is beautiful colored.
- Is long keeping.
- Is white fleshed—mild flavor.
- Is ideal for Onion Sets.

Brings a premium over all other onions in all markets.

So large is the demand for this remarkable Onion that out of nearly two million bags produced in California alone this year there is not a bag to be purchased in California today, except

Pkg. 10c. 1 oz., 25c. 1-4 lb. 75c



## MUZZY GOLDEN DWARF CELERY.

Variety highly recommended. Best variety.

Fairly early. When blanched it turns a golden yellow.

Straight stalk and very solid. Crisp. Recommended as one of the best all around celery. Free from strings. Short without being crooked.

Pkg. 10c, 1 oz. 20c. 1-4 lb. 60c.



## NEW YORK or WONDERFUL LETTUCE.

Round solid head, early, heat resisting. Comes in in carloads shipped early in the Spring from California. Very high in comparable flavor. Best recuperating powers. Pkt., 10c, 1 oz., 20c; ¼ lb., 60.

New York. or Wonderful Lettuce.

# *Novelties*

---



---

## BORECOLE (Kale) "EVERBEARING"

We consider this very hardy and prolific variety to be far superior to the old perennial Kale. It is the hardiest vegetable that we know, and survives the most severe weather conditions.

It forms a dense bush about 3 feet in height, which is one mass of green, tender, succulent shoots, and when cooked is far superior to any other Kale. It is a plant that should be in every kitchen garden, and is also extremely valuable for market work. During the hard winter of 1917-1918 this variety stood well when other varieties of green stuff suffered severely.

Per Pkt. 50c.

## TOMATO "ORANGE SUNRISE"

In their efforts to improve vegetables and flowers, horticulturists are apt in aiming at certain qualities to neglect others of scarcely lesser importance. As regards the Tomato, for instance, in the endeavour to produce gigantic clusters of globe-shaped scarlet fruit, the flavor has been largely overlooked, and yet most modern experts agree that the flavor of the older ribbed varieties is superior to that of the present day favorites.

The superb new Tomato we now offer has overcome this defect, and after exhaustive trials leading specialists have stated that, either raw or cooked, it possesses the finest flavor of any variety in cultivation.

It is the result of a cross between the best of red and yellow varieties, and bears fruit of a bright orange color. Possessing all the popular qualities of rounded form, medium size, and earliness, and appearing in large clusters, it is equally suitable for indoor and outdoor culture.

We are convinced that all who give the "Orange Sunrise" Tomato a careful trial will realize its high value, and that, notwithstanding popular prejudice in flavor of red Tomatoes, it will succeed in establishing itself as one of our leading varieties.

Per Pkt. 50c.

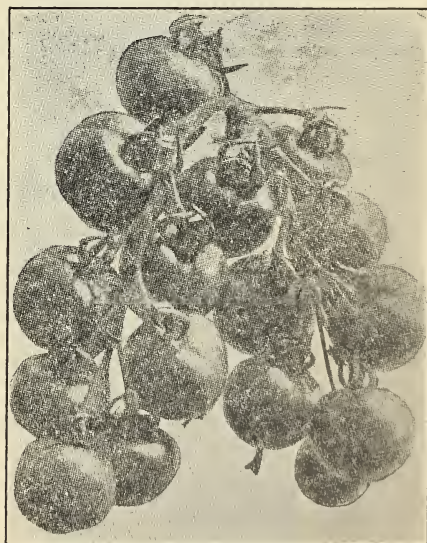

# Collection of Vegetable Seeds

Only the choicest sorts are put into the assortments, and they are picked out so as to give a continuous supply of vegetables from your garden all season.

The amount charged for these collections is considerably less than you would pay for the individual seeds, on account of the fact that we are able to put them up during the slack Winter months.

## PEACE COLLECTION for small Gardens \$1.00 (Including Postage in the U. S.)

1 Pa. Green Beans	1 Pa. Melon
" " Wax Beans	" " Parsley
" " Beets	" " Peas
" " Cabbage	" " Radish
" " Carrot	" " Spinach
" " Golden Bantam Corn	" " Turnip
" " Lettuce	" " Swiss Chard
" " Onion	

## COLLECTION NO. 1, All the popular varieties \$1.50 (Including free delivery.)

1 pa. Beans, Refugee Green-Pod.	1 pa. Lettuce, Big Boston.
½ lb. Beans, Golden Wax.	1 " Onion, White Globe.
1 " Beet, Egyptian.	1 " Parsley, Extra Curled.
1 " Cabbage, Early Wakefield.	½ lb. Peas, Thorburn's Extra-Early.
1 " Carrot, Half-Long.	1 pa. Radish, Scarlet Turnip.
½ ½lb. Corn, Early Bantam.	1 " Spinach, Viroflay.
1 pa. Cucumber, Imp. White Spine.	1 " Turnip, Snowball.
1 " Leek, Best Flag.	

## COLLECTION NO. 2 Fairly Complete. \$3.50 (Including free delivery.)

½ lb. Beans, Reugee Green-Pod.	1 pa. Leek, Best Flag.
½ lb. Beans, Golden Wax.	1 " Lettuce, Big Boston.
1 pa. Beet, Egyptian.	1 " Lettuce, Cos or Romaine.
1 " Beet, Globe.	1 " Melon, Long Island Beauty.
1 " Cabbage, Early Wakefield.	1 " Melon, Water, Black Spanish.
1 " Cabbage, Red, for pickling.	1 " Onion, White Globe.
1 " Carrot, Half-Long.	1 " Onion, Large Red Globe.
1 " Cauliflower, Thor. Gilt-Edge.	1 " Parsley, Extra Curled.
1 " Celery, White Plume.	1 lb. Peas, Extra-Early M'T.
½ lb. Corn, Early Bantam.	1 " Peas, Wrinkled, Our Selec.
½ lb. Corn, Stowell's Evergreen.	1 oz. Radish, Scarlet Turnip.
1 " Cucumber, Imp. White Spine.	1 pa. Spinach, Viroflay.
1 " Eggplant, Imp. N. Y. Purple.	1 " Tomato, Stone.
1 " Kohlrabi, Early White.	1 oz. Turnip, Snowball.



# MUZZY BROTHERS ANNUAL Seed Catalogue For 1920

Prices Subject to Change.

It is our endeavor to maintain the prices quoted in this Catalogue throughout the season, but owing to the present very unsettled conditions they are subject to change without notice.

Muzzy Brothers give no warranty, expressed or implied, as to the description, quality, productiveness or any other matter of any seeds, bulbs or plants they send out, and they will not be in any way responsible for the crop. If the purchaser does not accept the goods on these terms, they are at once to be returned.

## ARTICHOKE

German, Artichoke; French, Artichaut; Spanish, Albachofa.

	Pkt.	Oz.
French Globe .....	\$0.25	\$0.90
The Seeds should be sown early in the spring, in drills an inch and a half deep, and one foot apart. The next spring transplant to permanent beds, in rows or hills three feet apart and two feet between the plants. Plant in a deep rich, moist loam, and the plants should be protected in winter by a covering of leaves or coarse manure. A bed will continue bearing for several years.		
Jerusalem Artichoke, Tubers.....		25 cts. each

## ASPARAGUS

German, Spargel; French, Asperge; Spanish, Esparrago.

	Per oz.	¼ lb.	Per lb.
<b>Columbia</b> , producing			
pure white shoots....	.10	.30	1.00
<b>Conover's Colossal</b> ....	.10	.30	1.00
<b>Palmetto</b> , a light green			
variety .....	.10	.30	1.00
<b>Giant Argenteuil</b> , large			
stalks .....	.10	.30	1.00
<b>ROOTS</b>	Per	Per	Per
	50	100	1000
<b>Roots Colossal</b> , 2 years..	\$0.60	\$1.00	\$9.00
" <b>Palmetto</b> , 2 years	.60	1.00	9.00
" <b>Columbia</b> , 2 years	.75	1.25	10.00
" <b>Argenteuil</b> , 2 years	.75	1.25	10.00

Sow the seeds early in spring, in drills 15 inches apart, and about a dozen to the foot in the drill; keep the soil mellow and free from weeds during the summer, and in the succeeding spring transplant to permanent beds which should be done in the following manner as described by a cultivator of Oyster Bay Asparagus.

Plant on sandy soil. To grow Asparagus in perfection, the soil need not necessarily be richer than it must be to produce a good crop of corn. Some experiments have shown that by heavily manuring the crop cannot be made permanently greater than by moderate dressings. It is not desirable to plant them out very early; more plants will fail to grow than when the planting is deferred until the soil is dry and warm.

In planting for private use; set out in rows two feet apart, and allow twelve inches in the row. Set the plants at least six inches below the surface. For market on a large scale set four feet apart one way and two the other which will allow the use of a horse and cultivator to keep the weeds under.

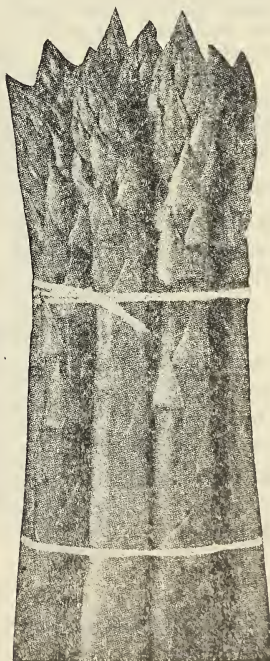

**BEANS**

15 Cents a PKT.

German, Gartenbohne; French, Fève de Marais; Spanish, Hava.  
English or Broad.

	1 lb.	2 lb.
Broad Windsor .....	\$0.60	\$1.00
Sword Lond Pod .....	.50	.90

This class is very hardy and should be planted as soon as the soil is in good state in the spring. Plant four inches apart, and two inches deep in drills four feet apart. To insure well filled pods, pinch off the tops as the lower pods begin to set.

**Bountiful, Extra Early.** Very prolific and long bearing. Flat greenpods, tender and stringless, 1 lb., 40c, 2 lb., 75c, 5 lb., \$1.75.

**Valentine Black,** long round, green, solid pod, very early. 1 lb. 25c; 2 lb. 50c, 5 lb. \$1.25.

**Valentine, Giant Stringless,** about seven days later than extra Early Valentine. Slightly curved pod, brittle and stringless; a strong grower and good yielder. 1 lb., 30c. 2 lb., 60c; 5 lb. \$1.50.

**Valentine, Early.** Productive, tender and of excellent flavor. 1 lb. 30c; 2 lb. 60c; 5 lb. \$1.50.

**Horticultural Dwarf, Late.** Productive, broad, flat stringless pods. 1 lb., 40c, 2 lb. 75c, 5 lb., \$1.75.

**Muzzy's Stringless Green Pod,** the best stringless bean grown. Ten days to two weeks earlier than the valentine; pods full and fleshy, extremely crisp and absolutely stringless. Very productive. 1 lb. 30c, 2 lb. 60c, 5 lb. \$1.50.

**Early Mohawk.** Very productive and of good quality, 1 lb., 40c; 2 lb., 75c; 5 lb., \$1.75.

**Long Yellow Six-Weeks,** early, excellent variety for general crop. 1 lb., 30c, 2 lb., 55c., 5 lb., \$1.25.

**Extra Early Refugee—Small to date.** Refugee Pods 2 weeks earlier. 1 lb. 35c; 2 lb. 65c; 5 lb. \$1.50

**Refugee or Thousand to One. (Late variety.)** The pods are round and full, stringless and of fine quality. 1 lb., 35c, 2 lb., 65c, 5 lb. \$1.50.

**DWARF LIMA AND DWARF WHITE BEANS.**

**Burpee's Bush Lima.** beans are large as Large Lima, stout growth, branches vigorously, bearing 50 to 200 large pods well filled with very large beans. 1 lb. 45c; 2 lb. 85c; 5 lb. \$2.00.

**Burpee's Improved Bush Lima,** an improved strain of B. B. L., much larger pods and beans, enormously productive, extra early. 1 lb. 50c; 2 lb. 80c; 5 lb. \$2.25.

**Fordhook Bush Lima.** 1 lb. 50c; 2 lb. 90c; 5 lb. \$2.25.

**White Marrowfat,** grown for sale in the dry state. 1 lb. 25c, 2 lb. 45c, 5 lb. \$1.00.

**Long White Kidney,** excellent as a shell bean, green or ripe. 1 lb. 25c, 2 lb. 45c, 5 lb. \$1.00.

**DWARF WAX VARIETIES.**

**Refugee Wax, Stringless,** good for early or late. Immense yielder. 1 lb. 40c, 2 lb. 75c. 5 lb. \$1.75.

**Golden Eyed Wax,** very early, prolific, free from rust. 1 lb. 40c, 2 lb. 75c, 5 lb. \$1.75.

**Round Pod Kidney Wax,** same as Wardell's, only round pods. 1 lb. 45c. 2 lb. 85c. 5 lb. \$2.00.

**Wardell's Kidney Wax,** extra early, long flat pods, very productive. 1 lb. 35c; 2 lb. 70c; 5 lb. \$1.75.

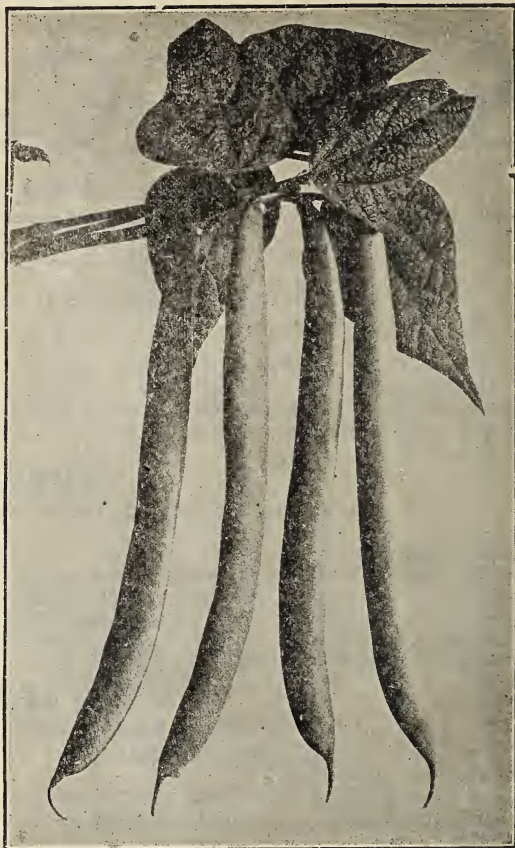

**BEANS—Dwarf Wax Varieties, Continued.**

<b>Curries Rust Proof</b> , very early and prolific. The pods are long, full, stringless; of very fine quality. ....	1 lb. .40	2 lb. .75	5 lb. \$1.75
<b>Davis' White Wax</b> , beans pure white pods, yellow, flat, tender, rich. ....	.35	.65	\$1.50
<b>Golden Wax</b> . This valuable variety is about ten days earlier than the black wax pods, large, long semi-round, brittle, stringless.....	.35	.65	\$1.50
<b>Hodson Wax</b> , very large, tender, pods stringless, very productive.....	.35	.65	\$1.50

**BEANS, Pole or Running Varieties.**

<b>Challenger Lima</b> . Potato variety, five and six a pod .....	.40	.75	1.85
<b>King of Garden Lima</b> . Vigorous in growth and immensely productive, pods large, numerous and well filled and beans of an enormous size, Generally grown for main crop .....	.40	.75	1.85
<b>New Early Jersey</b> . Very early .....	.40	.75	1.75
<b>Large White Lima</b> . A greatly esteemed variety .....	.40	.75	1.75
<b>Kentucky Wonder, or Homestead Extra Early</b> . Pods long tender and good flavor, very productive .....	.35	.65	1.50
<b>Dutch Case Knife</b> . A very productive variety, one of the earliest ....	.40	.75	1.75
<b>Horticultural or Speckled Cranberry</b> . A popular variety for private use, equally serviceable in the green state or when shelled .....	.35	.65	1.50
<b>Scarlet Runner</b> . Beautiful scarlet flowers; for ornamental and table use .....	.50	.90	2.10
<b>Early Golden Cluster</b> . Bright yellow pods, stringless, in clusters .....	.50	.90	2.10
<b>Yard Long, French</b> . Pods sometimes grow from 2 to 3 ft. long, are very slender like a pipe stem, should be grown on pea bush. Crop failed. ....	.60	1.10	2.50

Sow Bush sorts in drills about two feet apart, and drop the beans about three inches apart in the drill, cover two inches or less for a succession, sow at intervals of two weeks. Lima beans should not be planted until settled weather; make rich hills, four feet apart each way set a pole eight or ten feet high in each; press the beans into the soil eye down, six or eight to each pole, and when they are well up, thin out to four.

A quart of Limas is sufficient for 75 to 80 hills, and a quart of Bush Beans will sow a row 100 long.

**BEETS**

PKT. 5 Cents

German, Runkelrub; French, Bour-rache; Spanish, Remolacha.

**Detroit Dark Red**. A splendid beet for market or home use, of a deep color, tender and of delicate flavor.

Oz., 15c; ¼ lb., 50c., 1 lb., \$1.75.

**Dark Red Egyptian Crosby's**. The earliest beet in cultivation, color deep crimson; of excellent quality.

Oz., 15c., ¼ lb., 50c., 1 lb., \$1.50.

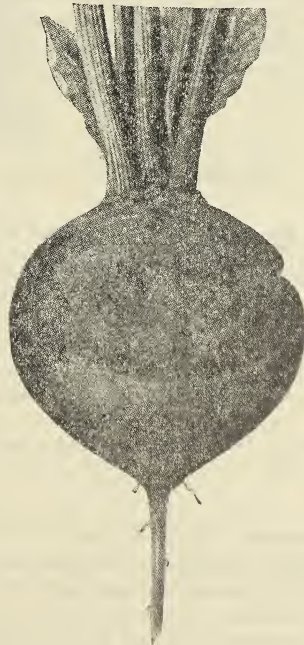

DETROIT DARK RED BEET.

**BEETS—Continued.**

	Per	¼	1 lb.
	oz.	lb.	lb.
<b>Extra Early Eclipse.</b> Very early good size. ....	15	50	1:50
<b>Early Flat Bassano.</b> Chiefly valuable for its earliness .....	15	50	1:50
<b>Early Blood Turnip.</b> Standard early sort, an excellent .....	15	50	1:50
<b>Edmands.</b> Market garden variety, uniform shape, dark .....	15	50	1:50
<b>Dewing's Blood Turnip.</b> Of fine form and flavor.....	15	50	1:50
<b>Long Smooth Blood Red.</b> An excellent late variety .....	15	50	1:50
<b>Swiss Chard.</b> Used for its leaves, which are cooked as Spinach } See	15	50	1.75
<b>Swiss Chard Lucullus.</b> .....			

**MANGEL-WURZEL AND SUGAR.**

Varieties used for feeding stock. Sow 6 lbs. per acre.

	Per oz.	¼ lb.	lb
<b>Mammoth Red Mangel-Wurzel.</b> Producing roots of mammoth size, very regular, and with a small top.....	.10	.30	1.00
<b>Yellow Orid Mangel-Wurzel.</b> Very productive .....	.15	.30	1.25
<b>Long Yellow Mangel-Wurzel.</b> Good for general crop.....	.10	.30	1.00
<b>Golden Tankard Mangel-Wurzel.</b> A new and very valuable variety of fine form and sweet flavor, bright yellow in color, when cut it shows interior ring, similar to most varieties of garden beet.....	.15	.40	1.25
<b>White Silesian Sugar Beet.</b> Extensively grown for feeding stock and manufacture of sugar .....	.15	.40	1.25
<b>Wilmorin's Improved Sugar Beet.</b> An improved variety.....	.15	.40	1.25
<b>Lane's Improved Sugar Beet.</b> Improved variety of the French Sugar Beet, obtained by careful selection in this country.....	.15	.40	1.25

A rich, deep open soil is the best suited to the culture of Beets. Fresh manure is undesirable but land that has been well manured the previous year is highly suitable. For an early supply sow in the spring as soon as the ground becomes fit to work, in drills about one foot apart and two inches deep. For main crop sow the first week in May, and for winter use sow in June. When the plants have obtained three or four leaves, thin out, so that they may stand eight or nine inches apart. Keep free from weeds by hand weeding and hoeing. Those intended for winter use may be taken up in October, and stored in dry sand in the cellar or outhouse. Before storing, leaves and fibers must be cut off, but care must be taken not to bruise the main root.

**BORAGE**

10c PKT.

German, Borritsch; French, Bourrache; Spanish, Berraja.

	Per oz.	¼ lb.	lb.
<b>Borage,</b> used as a pot herb; also as a salad, or can be boiled, and also for garnishing, but chiefly required for claret cups and other cooling drinks. Bees are very partial to the flower .....	.30	.75	\$3.00

**BROCCOLI** 10c . PKT.

German, Spragel Kohl; French, Chou Brocoli, Spanish Brocoli.

	Per oz.	¼ lb.
<b>Early White,</b> heads medium size, compact, creamy white color, most certain to head .....	\$0.50	\$1.50
<b>Purple Cape,</b> differing from the preceding color, greenish purple .....	\$0.30	\$1.00
<b>White Cape</b> .....	\$0.50	\$1.50
<b>Mammoth White</b> .....	\$0.50	\$1.50

A favorite European vegetable, nearly allied to the Cauliflower, but more hardy and surer to head; the seeds should be sown in this district in the early part of May and transplanted in June; farther south the sowing should be delayed until June or July, and the transplanting accordingly from August to October. In parts of the country where the thermometer does not fall below 20 or 30 degrees, broccoli may be had in perfection from November until March. It succeeds best in a moist and rather cool atmosphere.

**BRUSSELS SPROUTS** 10c. a PKT.

German, Sprossen-Kohl; French, Chou de Bruxelles; Spanish, Breza de Brussels.



**Dalkeith Dwarf Improved**, a variety producing compact sprouts of excellent quality. Pkt. 10c; Oz. .40c; ¼ lb. \$1.25.

A tender, delicious vegetable. The plant grows two or three feet high, and produced from the sides of the stalks numerous little sprouts, one or two inches in diameter, resembling cabbage. The leaves which look like a Savoy should be broken down in the fall, to give the little cabbages room to grow. They are very tender and sweet after early frosts. Sow early in hot-beds, or in seed-beds in May transplant and cultivate the cabbage.

**CABBAGE**

10 CTS. PACKAGE, except quoted otherwise

German, Kopfkohl; French, Chou; Spanish, Berza de pepollo

1 oz. ¼ lb. 1 lb.

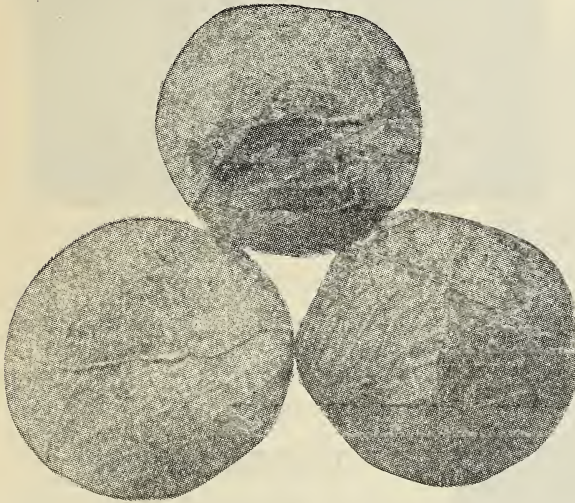

COPENHAGEN MARKET

**Copenhagen Market.**

The finest, large, round-headed, early Cabbage; very solid and of fine quality; short-stemmed .65 1.75 6.50

**Enkhuizen Glory.**

Large, early, white, solid, ball shaped heads ..... .60 1.75 6.00

**All Seasons**, fine variety, for second

early or late growing, good size..... .35 1.00 3.50

**Early Jersey Wake-**

field. The leading variety for market, very early, of medium size, good quality, sure to head.. .45 1.25 4.50

**Charleston Wake-**

field. Large strain of the above..... .45 1.25 4.50

**Autumn King.** We

believe this to be .35 1.00 3.50

**Early Flat Dutch.** This is one of the best early cabbages in cultivation..... .40 1.15 4.00

**Early Summer.** A valuable early sort resembling the Early Flat Dutch..... .40 1.15 4.00

**Early Winnigstadt.** Heads large, one of the best for general use..... .40 1.15 4.00

**Henderson's Succession.** A second early or late variety, a sure header; seeds sown in March produce large heads in June..... .40 1.15 4.00

**Muzzy Extra Amagar Danish Ball-Head.** Large, round, solid, sweet and crisp, sure header ..... .60 1.75 6.00

**Large Late Drumhead.** An excellent fall and winter variety, grows to a large size .40 1.15 4.00

**Larrie Late Flat Dutch.** The most popular variety for late cultivation..... .40 1.15 4.00

**Red Stone Head.** Used almost exclusively for pickling ..... .50 1.50 5.00

**Drumhead Savoy (American).** The largest heading sort, of excellent flavor..... .40 1.15 4.00

**Chinese (Pe Tsai)**..... .45 1.25 4.50

For very early use plant in the autumn from 10th to 25th, September, in a seed bed, and protect in cold frames during the winter, being careful to set them down to the first leaf. Transplant in the following spring, as the soil will admit. For autumn and winter use, plant in seed-bed in May and early part of June, and when six inches high transplant into rich soil, two feet apart each way for the early varieties, and three by two and a half feet for the large winter varieties. To secure the best results, the soil should not be too dry, but should be thoroughly enriched, and the crop should be hoed at least once in ten days. Sow in hot bed early in spring, seed of the early kind for a second crop; also the late varieties for winter use.

**CARROT ALL 5c PACKAGE.**

Except quoted otherwise.

German, Mochren; French, Carottee.

The Carrot, like other root crops, delights in a sandy loam, deeply tilled. It should never be sown on newly manured ground as forked roots are sure to be the result. It is best to sow on ground that has been well manured the previous year for some other crop such as Celery, Potatoes, Onions or Peas, but avoid such crop as Cabbage and Turnips, or any of the tap rooted sections. For early or main crops sow the latter part of April; for later crops, they may be sown any time until the beginning of June. Sow in rows about 15 inches apart and half an inch deep, thinning out to three or four inches between the plants.

**Early French Forcing.** The earliest variety, valuable for forcing; root small and of fine flavor, oz., 20c; ¼ lb., 60c; 1 lb., \$2.00.

**Early Scarlet Horn.** Old and favorite sort, much esteemed for early summer, oz., 20c; ¼ lb., 60c; 1 lb., \$2.00.

**Half Long Danvers.** A variety intermediate in size and period of maturity between the proceeding and the Dond Orange, oz., 20c; ¼ lb., 60c; 1 lb., \$1.75.

**Half Long Stump Rooted Chantenay.** Like Nantes, broader shoulder, oz., 20c; ¼ lb., 60c; 1 lb., \$2.00.

**Half Long Rubicon Finest Carrot in existence.** oz., 20c; ¼ lb., 60c; 1 lb. \$2.00.

**Half Long Stump Guarande or Oxheart.**

**Half Long Stump Nantes.**

**Long Orange Improved.** Roots of large size, equally adapted for garden or farm culture

**Large White Belgian.** Grown almost exclusively for stock

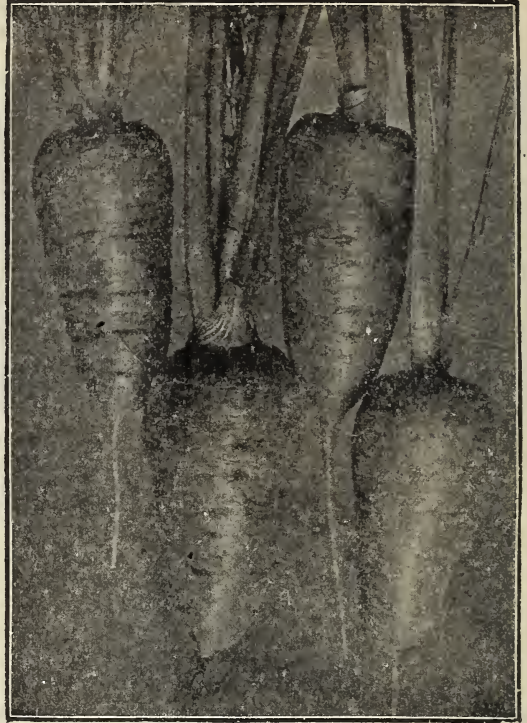

DANVERS CARROT.

	Per Oz.	¼-lb.	lb.
Half Long Stump Guarande or Oxheart.....	.20	.60	1.75
Half Long Stump Nantes.....	.20	.60	2.00
Long Orange Improved. Roots of large size, equally adapted for garden or farm culture .....	.20	.60	\$1.75
Large White Belgian. Grown almost exclusively for stock .....	.20	.60	1.75

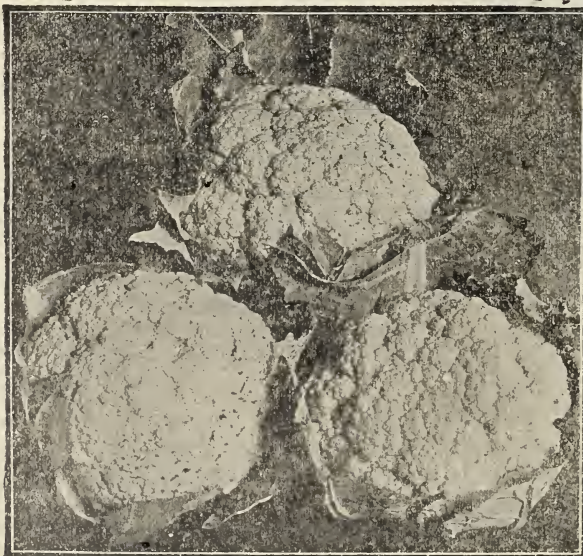

EARLY SNOW BALL CAULIFLOWER

**CAULIFLOWER**

German, Blumen-Kohl; French, Chou-fleur; Spanish Coliflor.

**Extra Early Paris.** This is one of the earliest and best varieties, heads large, white and compact, of fine quality, Pkt., 25c; ¼ lb., \$1.25; 1 oz., \$3.50.

**Large Early Snowball.** Best for forcing under glass or open ground. Pkt., 25c; ¼ lb., \$1.50; 1 oz., \$4.00.

**Early Dwarf Erfurt.** Best for forcing. Pkt., 50c; ¼ lb., \$2.75; 1 oz., \$8.00.

**Early London.** Pkt., 25c; 1 oz., \$1.00; ¼ lb., \$3.00.

**CAULIFLOWER—Continued**

**DENMARK. Special Large Late.** Very fine variety, large white compact heads, the space necessary between plants is greater than other varieties. Pkt., 50c; ¼oz., \$2.00; 1 oz., \$6.00.  
Cauliflower delights in rich, moist soil and in dry seasons should be abundantly watered. The seeds may be sown in September and wintered over in the same manner as described for early cabbage. Where this is not practicable, it may be had nearly as well by sowing the seed in the hot-bed in January or February and trans-planting the plants at two or three inches apart in boxes, or in the soil of another hot-bed, until such time as they are safe to be planted in the open ground, which in this latitude, is usually from the 15th of March to the 10th of April. If properly hardened off, they are seldom injured by being planted out too early.

**CELERY 10 CTS PACKAGE**, except quoted otherwise.

	Oz.	¼-lb.	lb.
German, Celeri; French, Celeri; Spanish, Aph. variety			
Golden Self-Blanching. American Strain. Very choice. Standard early variety	.65	\$2.00	\$1.50
Giant Pascal. Stalks very large, thick and crisp	.35	1.00	3.50
Golden Self-Blanching. Paris Strain. Similar to White Plume; much larger in growth. Solid, best variety in market. Pkt. 20c	1.00	3.00	10.00
White Plume. Requires very little banking	.40	1.25	4.00
Dwarf White, Soup Celery. An imported variety of fine flavor; soup greens	.15	.40	1.50
Boston Market. An excellent dwarf, growing white variety	.35	1.00	3.50
Covent Garden Red. Splendid Dark Rose variety. Nutty flavor	.75	2.75	10.00
Celery Seed for Flavoring	.10	.30	1.00

**CELERICAC**

10c. PKT.

**TURNIP ROOTED CELERY**

German, Knob-Celeri; French, Celeri Rave.

**Giant Prague.** For soups, etc. When sliced and cooked makes good winter salad. Oz., 25c; ¼ lb., \$1.00; lb., \$3.50.

**Apple.** Small foliage. Oz., 45c; \$1.25; \$4.50.

The seeds may be sown in the open ground in April, as soon as the ground can be nicely worked. Sow about half an inch deep, and be careful to firmly press the soil over the seed; this should be done by treading over the rows with the feet after sowing; this prevents the air drying up the seed, which thereby loses its vitality and fails to germinate. Many valuable crops are annually lost by inattention to this important particular. After the seed is up, keep carefully clear of weeds until the time of planting June and July; the crops may be shorn off once or twice before planting; this make them "stocky" and they suffer less in being transplanted. After the ground has been well prepared, plant in rows from three to four feet apart, according to the variety, setting the plants about six inches apart and pressing the soil firmly about the roots.

German, Bisenlauch; French Cerfeuil;

**CHERVIL**

PACKAGE, 10 CENTS

Spanish Cerafolio.

	Per oz.	¼-lb.	lb.
Curled	.50c	\$1.50	
Plain like above but not curled	.40	1.25	



**CELERY**

The young leaves are used in soups and salads. Sow thinly in May, in drills of an inch deep, one foot apart.

**CHICORY** PKT. 10 Cents.

German, Chicorie; French, Chicoree Saur; Spanish, Escarola.

Per oz. ¼-lb.

**Common.** This variety produces the "Barbe de Capucin," a salad much used in France. Sown in June the roots are transplanted in autumn into sand in a cellar; the shoots of which will come up soon from the "Barbe de Capucin"...

.35 1 25

**Large Rooted.** Used to mix with or a substitute for coffee. Cultivation same as the carrot.....

.35 1 25

**Witloof or French Endive.** See endive.....

.45 1.50

**CRESS**

PKT. 5c. Except Quoted Otherwise

German, Kress; French, Cressen; Spanish, Mastueroz.

**Curled Cress or Peppergrass**.....

.15 .50

**Water Cress**..... Pkt. 10c

1.00 3.50

Are excellent for small salads; the leaves, while young have a warm, pungent taste. They can be used alone or mixed with Lettuce, Mustard, or other salad plants. Sow thickly at frequent intervals for succession, and treat in the same manner as mustard.

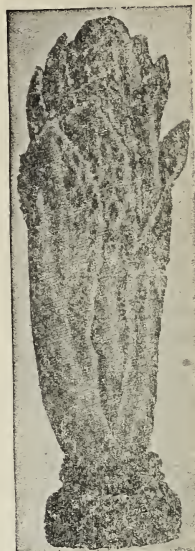

WHITLOOF  
CHICORY

**CORN SALAD OR FETTICUS** PKT. 5 Cents

German, Ackersalat; French, Mache; Spanish, Macha Valeneanilla.

Per oz. ¼-lb. lb.

**Large Seeded**.....

\$ .30 \$ .85 \$ 3.00



Corn Salad, Fetticus or Lambs Lettuce is used to a considerable extent as a salad. It is sown on the first opening of spring in rows one foot apart and is fit for use in six to eight weeks from the time of sowing. If wanted to come out early in spring, it is sown in September, cover up with straw or hay as soon as cold weather sets in and is wintered over the same way as Spinach.

**CORN---Sweet**

German, Zucker Welshkorn; French, Maise de Sucre; Spanish, Maiz de Azucar.

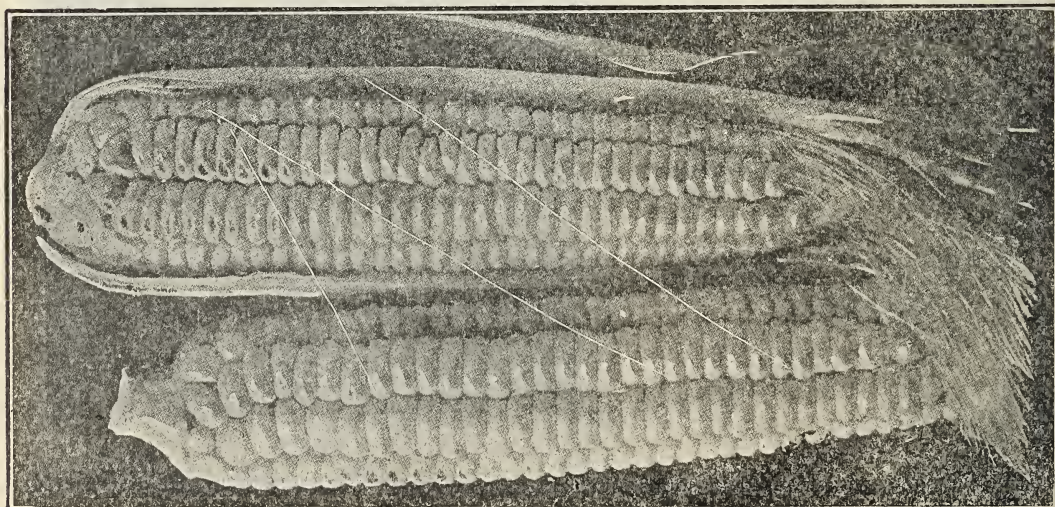



CORN—Continued.

EXTRA EARLY VARIETIES.

	Ear ½lb.	1 lb.	5 lbs.	15 lbs.
Early Dawn Extra Early. Earliest of all the Extra Early sweet corn .....	.10	.25	.40	1.75 3.75
Golden Bantam Extra Early. Yellow, very sweet and tender..	.10	.25	.40	1.75 4.50
Early White Cory. Earliest grown, fit for use 60 days after planting. Very sweet, good size, white cobs.....	.10	.25	.40	1.75 3.75
Mammoth White Cory. Ears double size of the old Cory.....	.10	.25	.40	1.75 3.75
Perry's Hybrid. Very early and of large size; extra early....	.10	.25	.40	1.75 3.75
Early Minnesota. Very early; ears fairly sized and uniformed plants rather dwarf; one of the best early kinds; extra early	.10	.25	.40	1.75 3.75

SECOND EARLY OR INTERMEDIATE.

Early Champion. Large ears, very sweet and productive. The earliest large sort grown and fine for either home or market use .....	.10	.25	.40	1.75 3.75
Crosby's Early Sugar. Early sorts; ears short, from 12 to 15 rows, second early.....	.10	.25	.40	1.75 3.75
Long Island Beauty Early. Excellent, medium early, large size, sweet .....	.12	.25	.40	1.75 3.75
Early Mammoth. Large second early .....	.12	.25	.40	1.75 4.50

GENERAL CROP AND LATE.

Stowell's Evergreen. A late variety, of excellent quality, remaining longer in the green state than any other; general crop .....	.12	.25	.40	1.75 3.75
Hickox Improved. A new variety of superior excellence is 12 rowed, straight and handsome; a superior market kind; general crop .....	.10	.25	.40	1.75 3.75
Mammoth Sugar. A late variety of large size, very sweet and immensely productive. A leading variety.....	.12	.25	.40	1.75 3.75
Country Gentleman. The sweetest and most tender of all sweet corn, late crop.....	.10	.25	.40	1.75 4.50
Black Mexican. One of the sweetest varieties.....	.10	.25	.40	1.75 4.50
Sweet Fodder. For ensilage.....		.25	.40	1.75 3.00

FIELD CORN, 8 CENTS EAR, 48 POUNDS BUSHEL EARS

	Ib.	5 lbs.	50 lbs.
Mastodon Dent. Very early strong growing .....	.30	1.00	7.50
Pride of the North. (Dent) very early .....	.30	1.00	7.50
Leamings Yellow. (Dent) early .....	.30	1.00	7.50
Champion White Pearl .....	.30	1.00	7.50
Early Canada. Yellow kernels .....	.30	1.00	7.50
Large Yellow Flint .....	.30	1.00	7.50
Large White Flint .....	.30	1.00	7.50
Chester County Mammoth. Large, late yellow dent .....	.30	1.00	7.50
Southern Horse Tooth. For fodder .....	.30	1.00	7.50
Eureka White Dent, for ensilage 12 to 14 rows, one of the best ensilage varieties, the fodder growing up to 17 feet, in some places matures in 120 to 130 days. See Novelties. ....	.25	1.75	6.00

PKT. Five Cents

**CUCUMBERS**

	oz.	¼ lb.	1 lb.
<b>Cumberland.</b> The best picking sort yet introduced, very handsome and productive, flesh fine but very crisp and tender.....	.15	.50	1.50
<b>Forhook Pickling.</b> Prolific, medium size, skin thick.....	.15	.45	1.25
<b>Davis Perfect.</b> For forcing or outdoors, long and straight. valuable for slicing .....	.15	.50	1.50
<b>Cool and Crisp.</b> Very prolific; good for pickling and productive.....	.15	.50	1.50
<b>Thorburn's Everbearing.</b> Small size; very early.....	.20	.60	1.75
<b>Japanese Climbing.</b> Can be trained on trellis, or grown on the ground. Skin smooth, dark green; flesh pure white, crisp and mild flavor.....	.20	.60	2.00
<b>Nichols Medium Green.</b> A valuable and handsome variety, in shape between White Spine and Long Green, an excellent sort for pickles and useful for forcing. Very prolific, fruit straight and smooth, color dark green; fresh, tender and crisp.....	.15	.45	1.25
<b>Improved Early White Spine.</b> The best table variety; grows uniformly straight and smooth; dark green; and tender and excellent flavored....	.15	.45	1.25
<b>Peerless White Spine.</b> A new variety of the proceeding; average length 10 inches; full at both ends; deep green, holding color until mature.....	.15	.45	1.25
<b>Arlington White Spine.</b> Fine either for forcing or for outdoors.....	.15	.45	1.25
<b>Early Green Cluster.</b> A short, prickly, slender variety, bearing in clusters near the root. It is a great bearer.....	.15	.50	1.50
<b>Early Short Green.</b> The standard or pickling, medium size, straight and handsome. It makes a beautiful pickle that keeps well.....	.15	.45	1.25
<b>Long Green.</b> A very excellent variety; a good bearer; about a foot in length rather pointed at both ends; dark green, firm and crisp.....	.20	.60	2.00
<b>Green Prolific Pickling.</b> Very prolific; and said by those who have tested it equally desirable as a market Cucumber.....	.15	.50	1.50
<b>West Indian Gherkin or Burr.</b> A very small oval shaped prickly variety. It is grown exclusively for pickling, and should always be picked when young and tender.....	.30	.85	3.00

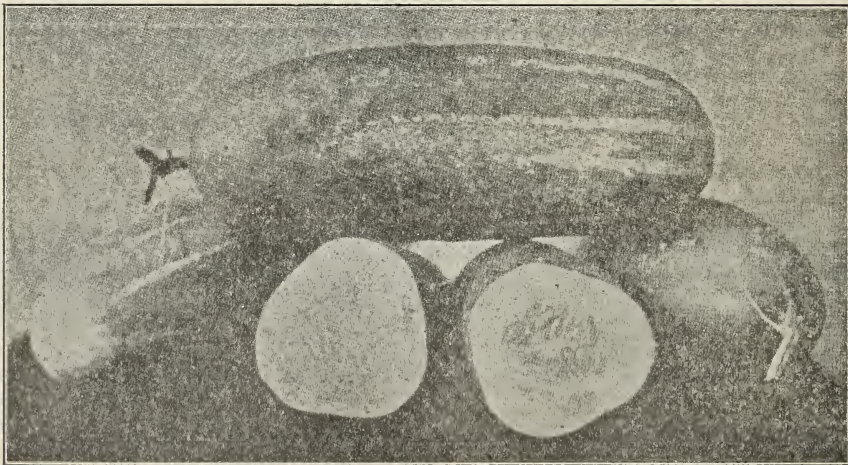

Cucumbers succeed best in warm, moist rich loamy ground. They should not be planted in the open air until there is a prospect of settled warm weather. Plant in hills about four feet apart each way. The hills should be previously prepared by mixing thoroughly with the soil in each a shovelful of well rotted manure. When all danger from insects is past, thin out the plants, leaving three or four of the strongest to each hill. English Frame Cucumber—Per pkt., 25c. Improved Sion and True, Swan Neck, Blue Gown.

These varieties are for growing in hot-beds, or in hot-houses, particularly constructed for forcing, so that a supply can be furnished during the winter months, at which time the prices are very remunerative. Sow seeds in November, December and January, according to the time they are wanted for market.

**DANDELION**

5c. PKT.

German, Pardelblume; French, Pisse en-lit; Spanish, Armagon.



DANDELION

Per oz. ¼ lb. lb.

Best French..... \$0.40 \$1.25 \$4.50

The Dandelion is much used for spring salads and resembles Endive. Sow the seed in May or June in drills half an inch deep and 12 inches apart. The plants will be ready for use the following spring.

**ENDIVE OR CHICKORY**

All 5c. PKT.

German, Endevien; French, Chicoree; Spanish, Endivia.

	Per oz.	¼ lb.	lb.
Green Curled Winter. Very hardy; leaves dark green, tender and crisp.....	\$0.20	\$0.60	\$2.00
Broad Leaved Batavian. (Escarolle), chiefly used in soups and stews; requires to be tied up for blanching.....	.20	.60	2.00
Early White Curled. (Self-blanching), the best variety; grows to large size; very large and tender .....	.20	.65	2.25

Moss Curled Early Summer. Used for salads as winter varieties .....	20	.65	2.25
---	----	-----	------

Witloff or French Endive. New.....	1 oz.	45	¼ lb \$1.50
------------------------------------	-------	----	-------------

Endive is one of the best salads for fall and winter use. Sow for an early supply about the middle of April. As it is used mostly in the fall months, the main sowings are made in June and July, from which plantations are formed at one foot apart each way in August and September. It requires no special soil or manure, and after planting, is kept clear of weeds until the plant has attained its full size, when the process of blanching begins. This is affected by covering up the plants as they grow, with slats or boards, which serves the purpose of excluding the air and light.

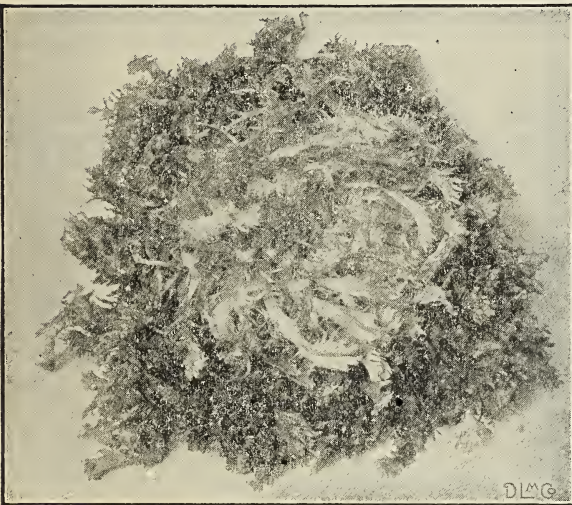

ENDIVE

**EGG PLANT**

All 10c PKT.

German, Eier Pflanz; French, Aubergine; Spanish Bereinfiena.

Long Purple—long and thin, fine quality. Per oz. 80c; ¼ lb. \$2.75.

New York Improved. Superior market variety of large size and fine quality.....\$ .75 \$2.50

Black Beauty Tendage. Earlier than New York. Improved and as large, purplish black..... .80 2.75

Early Dwarf Purple. Medium size..... .80 2.75

Black Pekin. A fine variety, bearing large round, deep, purple fruits, fine, grand and of superior quality..... .80 2.75

The Egg Plant is a tender vegetable, and must not be planted out until the weather is warm and settled. Sow early in spring in hot-beds, or if they are not convenient, sufficient plants may be raised for a small garden by sowing a few seeds in common flower pots or in boxes in the house. Plant out early in June from two to three feet apart.



NEW YORK EGG PLANT

**KALE**

PKT 5 Cents

Except where noted

German, Blatter-Kohl; French, Chou Vert; Spanish, Breton.

Oz. ¼ lb. 1b.

**Siberian German Green or "Sproute."** This variety is extensively used for early greens for which it is sown in the fall in rows one foot apart and treated in the same manner as Spinach; it is ready for use in early spring. Sowing can also be made in spring..... .20 .60 1.75

**Dwarf Green Curled Scotch.** Beautifully fringed dwarf growing kind, with bright green leaves, 10c pkt. .30 .85. 3.00

**Tall Green Curled Scotch.** Tall growing, very hardy variety, leaves a bright green, beautiful curled..... 10c pkt.....30 .85 3.00



KALE

Kale may be grown in almost any soil, but the richer it is the more abundant the product. Sow early in the spring, in prepared beds, covering the seeds thinly and evenly; transplant in June and treat in the same manner as for cabbage. Of all the cabbage tribe this is the most tender and delicate and would be much more extensively grown than it is, if its excellent qualities were generally known. The varieties are all extremely hardy, and are best when touched by frost.

**KOHL-RABI**

PKT. 10 Cents

German, Kohl-Rabi; French, Chou Rave; Spanish, Colinabo.

Per oz. ¼ lb. 1b.

**Early White Vienna.** Flesh white and tender; best market sort; good for table use ..... .40 1.00 3.50

**Early Purple Vienna.** Differing from the above in color, which is of a bluish purple ..... .40 1.00 3.50

**Large White or Green.** Large ball, not so fine, but more productive.... .40 1.00 3.50

Kohl-Rabi or Turnip stemmed cabbage, is a vegetable that is not so much cultivated as it deserves to be. The stem above the ground swells into a bulb, somewhat resembling a turnip: this again is covered with leaves. The edible part is the bulb, which is dressed and served like turnip, and is very delicate and tender when young. It is very hardy, withstands severe drought, and is a good keeper. Cultivate the same as cabbage, but in hoeing be careful not to throw dirt into the heart of the plant, or the bulb cannot form.



KOHL-RABI

**LEEK** PKT. 5 Cents

German, Lauch; French, Poireau;  
Spanish, Puerro.

**Large American . Flag.**

The kind mostly  
grown for market.... .30 .90 3.00

**Large Careten. A large**

growing French var-  
iety of excellent qual-  
ity ..... .38 .90 3.00

**Large Rouen. Very**

large and fine..... .30 .90 3.00

The Leek is very hardy and easily cultivated; it succeeds best in a light, but well enriched soil. Sow as early in the spring as practicable, in drills one inch deep and one foot apart. When six or eight inches high they may be transplanted in rows ten inches apart each way, as deep as possible; that the neck, being covered, may be blanched. If fine leeks are desired, the ground can hardly be made too rich.

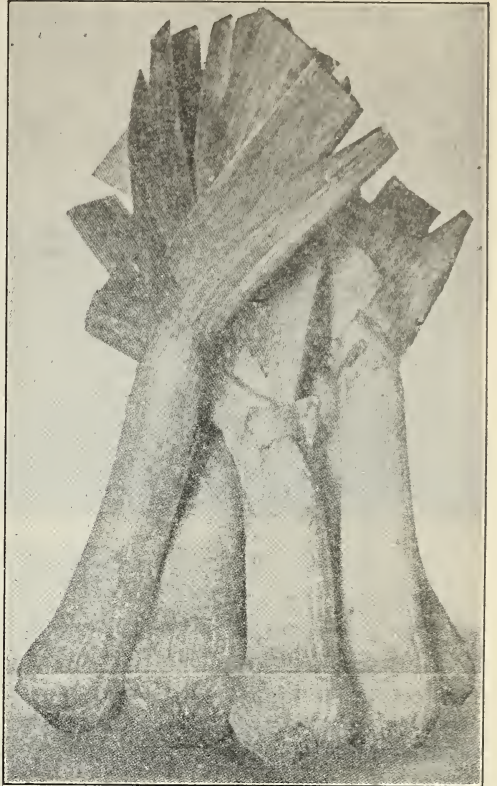

**LEEK**

**LETTUCE** PKT. 5 Cents

German, Laitick; French, Laitue; Spanish, Lechuga.

For early crop, the seed may be sown in the open ground in September, and transplanted to coldframes as soon as large enough to handle. In dry, sheltered spots, by covering up with leaves late in the season. Lettuce plants may be saved over Winter without glass covering. The plants for setting out in Spring are also sown in coldframes in February, and in hotbeds in March, and by careful covering up at night make plants to set out in April.

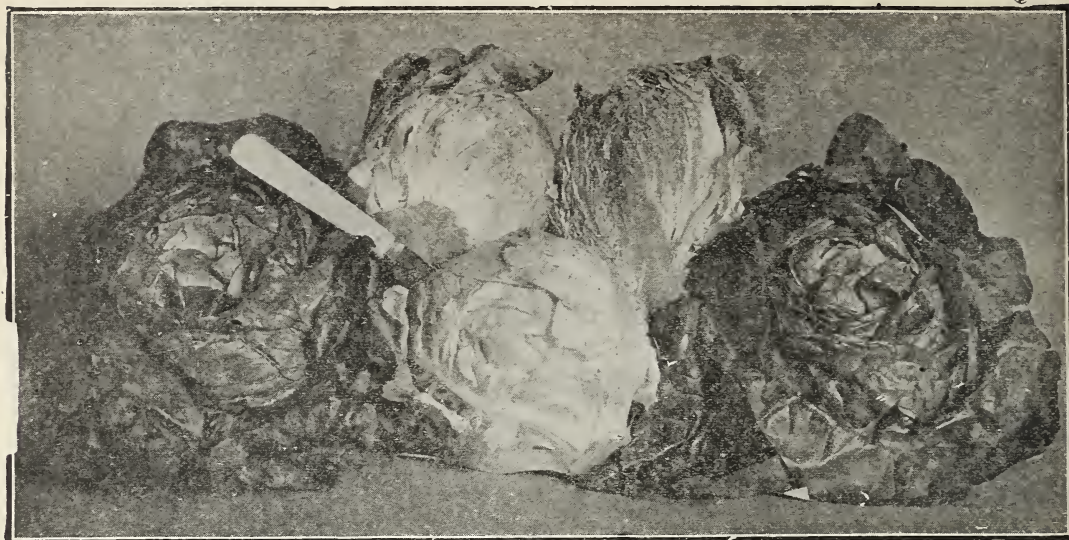

## MAY KING LETTUCE

LETTUCE—Continued.

German, Laitick; French, Laitue; Spanish, Lechuga.

	Per oz.	¼ lb.	lb.
<b>MAY KING LETTUCE.</b> Very early, sure header, solid, good flavor....	\$0 .15	\$0 .50	\$1.40
<b>Thorburn's Maximum.</b> Large and solid heads, heat resisting .....	.15	.45	1.25
<b>Selected Buttercup.</b> Yellow, solid heads for outdoor forcing .....	.15	.45	1.25
<b>Big Boston.</b> Similar to Boston Market, double this size .....	.15	.50	1.50
<b>Early Curled Simpson.</b> Very early and an excellent sort for forcing; is largely grown by the market gardeners .....	.15	.45	1.25
<b>American Gathering.</b> Twisted and curled leaves, fine for early or late ....	.15	.45	1.25
<b>Deacon.</b> This magnificent Lettuce stands hot weather better than any other Butter variety. Large, firm heads of creamy white and rich flavor.....	.15	.45	1.25
<b>Denver Market.</b> For forcing or open ground; large solid heads .....	.15	.50	1.40
<b>Tennis Ball.</b> (Black seeded), well formed heads hardy and crisp, one of the earliest of heading varieties .....	.15	.50	1.40
<b>Salamander Head.</b> Fine compact head, resists heat .....	.15	.50	1.00
<b>Black-Seeded Butter.</b> Fine market strain .....	.15	.50	1.50
<b>Large White Cabbage.</b> Excellent for summer; heads of good size .....	.15	.50	1.75
<b>Black Seeded Simpson.</b> Stands the summer well .....	.15	.50	1.50
<b>Gray Seeded Butter.</b> One of the best large heads .....	.15	.45	1.25
<b>Shotwell's Brown Head.</b> Large and handsome; heads hardy; standing summer heat without injury .....	.15	.45	1.25
<b>Boston Market.</b> Large solid heads, very fine for forcing, and of fine flavor.	.15	.50	1.50
<b>Iceberg Favorite Summer Lettuce.</b> .....	.20	.60	2.00

## ROMAINE OR COS VARIETIES.

<b>Red Cos.</b> outer boon red brown.....	.15	.50	1.75
<b>Trianon Cos.</b> The best of the Cos variety .....	.15	.50	1.75
<b>White Paris Cos (Romaine).</b> Sow early; tie up to blanch .....	.15	.50	1.75

Lettuce is the most popular of all salads. Boiled, is quite equal to Spinach; and it is also sometimes used in soups. It is easy of cultivation, but likes a good rich soil. For early use, sow Simpson and Tennis Ball under glass in February and March and transplant as soon as the ground can be worked. Later sowings may be made in the open ground for successions as long as the weather permits; thin out well or the plants will be weak, and set in rows two feet apart and eight inches between the plants. The best early plants are obtained by sowing in the open ground in September, and transplanting to cold frames the latter part of October, being wintered over in the same manner as early Cabbage. Lettuce requires good ground and abundant moisture.

**MELON, MUSK PACKAGE 5 CENTS**

German, Melone; French, Melon; Spanish, Melon Muscatel.

	Per oz.	¼ lb.	lb.
Honey Dew. Large, round, delicious, rich green flesh.....	\$.20	\$0.60	2.25
Paul Rose. Handsome, oval orange flesh, sweet.....	.20	.55	1.90
Long Island Beauty. Similar to Hackensack; very early.....	.25	.75	2.50
Miller's Cream or Osage. Flesh and salmon color and very thick.....	.20	.60	2.00
Golden Netted Gem. Early, round, fine small, fine flavor.....	.20	.60	2.00
Hackensack. Variety of Green Citron, well known among the New York market gardeners, grows to a very large size, productive, exquisite flavor,....	.20	.60	2.00
Montreal Market. Green flesh, very thick, fine flavor.....	.20	.60	2.00
Long Yellow Cantalope. Yellow flesh, suitable for the market.....	.20	.60	2.00
Baltimore Market. Oblong; orange flesh.....	.20	.60	2.00
Jennie Lind. A very early kind, of small size, but delicious flavor.....	.15	.50	1.50
Cassaba—Good water melon, sweet melting—must be fully ripe. Pkt. 10c		.35	1.25
Rocky Ford. Very sweet; spicy flavored, small and oblong, most popular sort	.20	.60	2.00

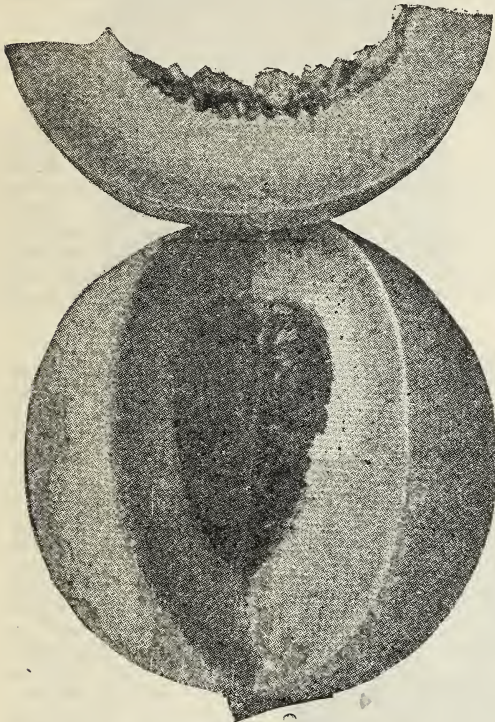

HONEY DEW MELON

Melons thrive best in a moderately enriched live soil; the hills should be six feet apart each way. Previous to planting incorporate well with the soil in each hill a couple of shavelfuls of thoroughly rotted manure; plant twelve or fifteen seeds in each hill early in May, and when well up, thin out three or four of the most promising. Pinch off the leading shoots as the growth becomes too luxuriant, and if the fruit sets too numerous thin out when young, which will increase the size of those remaining, and cause them to ripen quicker.

**MELON, WATER PACKAGE 5 CENTS**

German, Wassermelone; French, Melon d'Eau; Spanish, Zaudia. Per oz. ¼ lb. lb.

Tom Watson. Long and 8 to 10-in. diameter. Thin rind, crisp flesh, fine flavor	\$0.10	\$0.30	1.00
Kolb's Gem. Nearly round, dark green.....	.15	.40	1.25
Seminole. A new early variety. Long striped sort.....	.10	.30	1.00
Pride of Georgia. Dark green, oval in shape; crisp and sweet; very large.....	.15	.50	1.50
Mountain Sweet. One of the very best for culture; color dark green; rind thin; flesh scarlet; solid, very sweet and delicious.....	.10	.30	1.00
Black Spanish. Shape round, rather small; skin dark green, flesh red, sweet, rich.....	.15	.40	1.25
Phinney's Early. Flesh deep red, of a very superior quality; a valuable early market variety.....	.15	.40	1.25
Cuban Queen. Solid and heavy.....	.15	.40	1.25
Ice Cream. (White seeded), fruit of medium size, nearly round; skin pale green; rind thin; flesh scarlet, solid crisp, excellent.....	.10	.30	1.00

**MELON, WATER—Continued.**

<b>Rattlesnake.</b> Very large, striped, red flesh variety .....	Per oz.	¼lb.	1b.
<b>Mammoth Iron Clad.</b> Long and large; thin skin deep red flesh .....	\$0.15	\$ .40	\$1.25

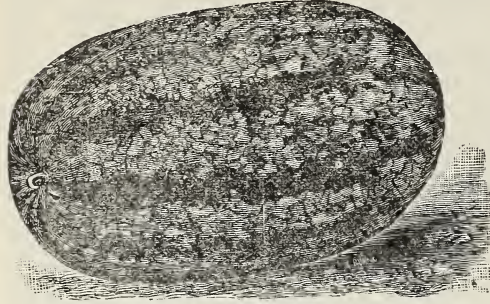

**IRON CLAD**

<b>The "Boss" Oblong;</b> dark green .....	.15	.50	1.50
<b>Citron.</b> (Red seeded), round handsome fruit of small size and used in the making of sweetmeats or preserves .....	.15	.40	1.25
<b>Citron.</b> (Green Seeded), used for preserves .....	.15	.40	1.25

Plant in hills directed for Muskmelons, giving them more room, as their vines extend much farther. If they are wanted of a large size, three or four melons to each plant will be sufficient, and when only one is allowed to grow from each plant they will grow to an immense size.

**MUSHROOMS**

German, Chimpignoubrut; French, Champignon; Spanish, Hongo.

<b>Imported English Spawn</b> .....	per brick, 25c; 10 bricks, \$2.50; 20 bricks, \$4.00
<b>Imported French Spawn</b> .....	About 2lb. Box \$1.25
<b>American Spawn Bricks</b> .....	per brick, 30c; 10 bricks \$2.75; 20 bricks \$5.25

Mushrooms should be grown either in a building especially erected for the purpose or some shed, stable or cellar, where the temperature of from 40 to 60 degrees can be kept up in winter. To every barrow load of fresh horse droppings add about the same weight of loam or soil of any kind that has not been manured. Turn the heap every day, so that it is not allowed to heat violently, until you have quantity enough to form a bed of dimensions required. Be careful that your heap is under cover, so that it cannot possibly get wet. The most convenient size is from three to four feet long and eight inches deep.



**MUSHROOMS**

soil over the heap to the depth of two inches, firm it down moderately and cover with three or four inches of hay or straw. Examine the bed often to see that it does not get dry. When water is given it should be at a temperature of about 100 degrees.

Prepare the mixture of loam and manure, making the bed in layers and pounding down each with the back of a spade. Leave this to heat through for a few days, and as soon as the heat subsides to 90 degrees, make holes in the bed about a foot apart each way into which put pieces of spawn two or three inches in diameter; fill up the holes with the compact and at the expiration of a week or ten days the spawn will have thoroughly diffused itself through the bed. Now spread a layer of fresh

**MUSTARD**

German, Senf; French; Moutarde; Spanish, Mostaga.

<b>White London.</b> Best for salads.....	Per oz.	¼ lb.	1 lb.
<b>Black.</b> Used for cooking and salad .....	\$0.10	\$0.30	1.00
	.10	.30	.90

Mustard in the green state is a refreshing salad, mixed with Cress, Lettuce, or other salad plants. It is necessary to make frequent sowing of it, as it should be cut and used in a very young state, even before the first rough leaf appears. The seed should be sown thickly in light soil, the surface of which should be made very smooth. The seed should be pressed into the soil with the back of a clean spade.



**NASTURTIUM PACKAGE 5 CENTS**

German, Nastrutian; French, Capusine; Spanish, Maranuela.

	Per oz.	¼ lb.	1 lb.
Tall Scarlet .....	\$0.20		
Tall Yellow .....	\$0.20		
Tall Nasturtium, Mixed .....	.15	.50	1.50
Dwarf Nasturtium, Mixed .....	.20	.60	2.00

Cultivate both for use and ornament; the green seed pods preserved in vinegar make an excellent pickle. The young leaves are also useful in salads. Its scarlet and orange-colored flowers which appear freely all summer, add a charm to the garden.

**ONION PACKAGE 10 CENTS**

German, Zwiebel; French, Oignon; Spanish, Cebolia. —

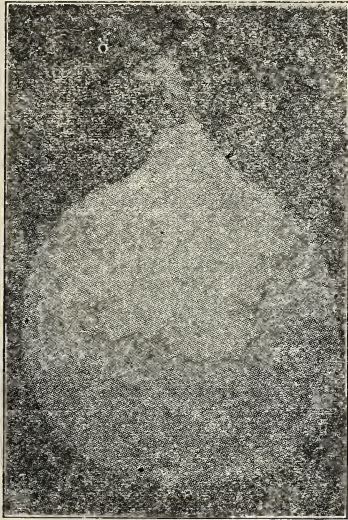

Yellow Globe Prize Taker, 90 days

	Per oz.	¼ lb.	1 lb.
Early Red Flat. About ten days earlier than the Large Red, and not quite so large....	.30	.85	\$3.00
Large Red Wethersfield The staple variety of the Eastern onion growers; of large size, deep in color, a good keeper .....	.30	.85	\$3.00
Southport Red Globe. Similar to the large Red in flavor and color, but quite distinct in form, being nearly globular .....	.40	1.25	4.00
Red Flat Bermuda. Very early sold out.....			
White Portugal or Silver Skin. A handsome onion of mild flavor; extensively grown for pickling .....	.30	.85	3.00

Southport White Globe. From nearly ovoid symmetrical, keeps well is an excellent variety.....	.35	1.00	3.50
White Flat Bermuda... Very early.....	.35	1.00	3.50

**ITALIAN VARIETIES.**

Adriatic Barletta. White, new variety, fully two weeks earlier than the Queen.....	.45	1.50	4.50
Early Queen. Excellent variety, very early, a good keeper and mild flavor, white.....	.40	1.25	4.00
Yellow Globe Danvers. An excellent variety, mild and very productive; ripens early and a good keeper.....	.30	.85	\$3.00
Prizetaker or Early Globe Spanish. Immense size.....	.35	1.00	3.50
Southport Yellow Globe. Same as above, except in color.....	.30	.85	\$3.00
Giant Rocca. A splendid large variety from Naples, of globular shape, bright brown skin and delicate flavor.....	.40	1.50	4.50

The onion thrives best in a rather strong, deep, rich loamy soil, and unlike most vegetables succeeds well when cultivated on the same ground for successive years. The ground should be deeply trenched and manured the previous autumn, and laid up in ridges during the winter to soften. As early in the spring as the ground is in working order, commence operations by leveling the ground with a rake, and tread firmly; sow thinly in drills about a quarter of an inch deep and one foot apart; cover with fine soil and press down with the back of a spade or a light roller. When the young plants are strong enough, thin gradually so that they stand three or four inches apart.

**ONION SETS**

White Onion Sets .....	lb. 35 cents
Yellow Onion Sets .....	lb. 30 cents
Red Onion Sets .....	lb. 30 cents
Potato Onions .....	lb. 35 cents
Shallots .....	
Red Top Onions .....	lb. 35 cents

**OKRA OR GUMBO PACKAGE 5 CENTS**

German, Essbarer Safran; French, Gomo; Spanish, Quibombo.



LONG GREEN OKRA.

	Per oz.	¼ lb.	1 lb.
Improved Dwarf White. Long slender pods, very productive, only 14 inches high.....	\$0 .10	\$0.30	\$1.00
Dwarf Green. Early and productive .....	.10	.30	1.00
Long Green. Fine long pods, very good .....	.10	.30	1.00

The pods in a young state are used in soups, sauces and stews, and are very wholesome and nutritious. It is the easiest culture and grows freely, bearing abundantly when grown in ordinary garden soil. It is sown at the usual time of all tender vegetables in drills two inches deep, setting the plants from two to three feet apart.

**PARSNIPS PACKAGE 5 CENTS**

German, Pastinake; French, Panals; Spanish, Chirivia.

	Per oz.	¼ lb.	1 lb.
Guernsey or Cup. Leading variety .....	\$0.15	\$0.50	\$1.50
Long Smooth or Hollow Crown. Long roots .....	.15	.50	1.50
Early Round. ....	.15	.50	1.50

They succeed best in a deep rich soil that has been well manured the previous season, as manure freshly applied tends to the production of forked and ill-shaped roots. Sow the seed early in spring in drills eighteen inches apart in the garden, and three feet apart in the field, thin the plants to six inches in the drill.

**PARSLEY PACKAGE 5 CENTS**

German, Petersilie; French, Persil; Spanish, Perjil.

	Per oz.	¼ lb.	1 lb.
Extra Double Curled. A fine dwarf variety excellent for garnishing .....	\$0.15	\$0.50	\$1.50
Moss Curled. The most beautiful form of parsley, resembling crested fern or moss in its growth .....	.15	.50	1.50
Plain Leaves. Hardier than the curled variety.....	.15	.40	1.25
Hamburg, or Rooted. Edible roots .....	.20	.60	1.75

Should be sown very early in the spring in beds or in lines, and the seeds which are somewhat slow to vegetate should be previously soaked 24 hours in warm water. The soil should be kept free from weeds, which should be extracted by the hand, so as to avoid disturbance of the seed when about to germinate. As soon as the plants are large enough they should be thinned out so as to stand five or six inches apart.

**PEAS PACKAGE 15 CENTS**

German, Erbsen; French, Pois; Spanish, Guisantes.  
Extra Early Varieties

	1 lb.	2 lb.	5 lb.
Harvester. Medium Early. Large double podded: Heavy cropper. flavor. Vines dark green and very sturdy .....	\$0.55	\$1.00	\$2.25
Gradus or Prosperity. Earliest wrinkled Pea grown. Can be sown early as the round sorts. Large peas and pods, splendid flavor. Requires no sticks, reaching only 36 inches in ordinary good soil. Height, 3 feet....	.55	1.00	2.25
Thomas Laxton. A cross between Gradus and one of the extra early sorts Ripens within a day or two of the earliest round varieties; very productive The pods are large and contain 7 or 8 large, wrinkled Peas of the finest flavor .....	.55	1.00	2.25

PEAS—Continued.

1 lb. 2 lb. 5 lb.

World's Record. 10 days earlier than Gradus.

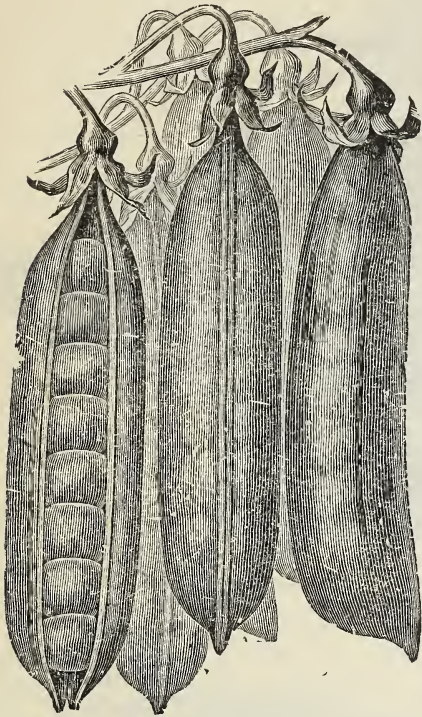

Nott's Excelsior. Extra dwarf wrinkled, pods larger than American Wonder, 1 foot .....	.50	.95	2.25
American Wonder. Earliest wrinkled variety, 1½ feet.....	.45	.85	2.00
Alaska. Very early and retain their color well, height 2½ feet.....	.40	.75	1.75
First and Best. One of the best extra early Peas. An improved strain of the Extra Early Market, height 2½ ft.	.45	.85	2.00
Little Gem. A dwarf green wrinkled Market, very prolific, of superior flavor, and a first early, 1½ feet.....	.50	.95	2.25
Premium Gem. A fine flavored dwarf, wrinkled variety; good cropper and fine quality. Height, 18 inches.....	.50	.95	2.25

SECOND EARLY VARIETIES.

Heroine Medium Early. Green wrinkled, height, 2½ feet.....	.45	.85	2.00
Everbearing. Good size pea, long pod, height 2½ feet.....	.45	.85	2.00
McLean's Advancer. Early green wrinkled varieties, delicious flavor, height 2½ feet.....	.40	.75	1.75
Pride of the Market. Very large pods, green peas, sow thin, height 2 ft.	.45	.85	2.00
Yorkshire Hero, or Dwarf Champion	60	1.10	2.50
Abundance. 18 inches high, 6 to 8 peas in pod, large and wrinkled.....	.45	.85	2.00
Dwarf Telephone. Same quality and productiveness as Telephone excepting the vines grow 2 feet high, pods are large and filled with immense peas of excellent flavor and very sweet.....			Crop failed.

GENERAL CROP.

Champion of England. A popular wrinkled variety of delicious flavor. profuse bearer. Peas are very large, tender, height 5 feet .....	.60	1.10	2.00
Telephone. This is the best pea for general crop, both for home and market use. Immediately productive and of finest quality. Vines very strong, averaging 18 to 20 large pods per stalk, 4 feet.....	.60	1.10	2.50
Stratagem. Mammoth pods, well filled, height 1½ feet .....	.55	1.00	2.25
Black-Eyed Marrowfat. Grown for market, hardy, productive, 3 ft. bu. \$4.00.	.40	.75	1.75
Mammoth Gray Sugar. Edible pods, a fine flavored variety; can be used in green state like string beans. Height 5 feet.....	.55	1.00	2.25
Dwarf, Sugar. Edible pods.....	.55	1.00	2.40

Peas come earlier to maturity in light soil. For general crop a deep rich loam, or strong loam inclining to clay is best. For early crops decomposed leaves or leaf mould should be used, or if the soil is very poor, strong manure may be employed. For general crop a good dressing should be applied, and for the dwarf growing kinds the soil can hardly be too rich. When grown as a market crop, peas are not staked, but sown in single rows, two or three inches deep, two or three feet apart according to the variety. When grown in small quantities for private use.

PEAS—Continued.

they are sown in double rows six or eight inches apart, and the rows three feet apart, the tall varieties staked up by brush. For an early crop, sow as soon as the ground can be worked, and make repeated sowings every two weeks for succession. A quart is sufficient for a row of about eighty feet.

**PEPPER** PACKAGE 10c.

German, Pfeffer; French, Piment; Spanish, Pimento.



PEPPERS.

	Per oz.
<b>Ruby King.</b> Very large; bright red .....	\$0 75
<b>Sweet Spanish.</b> One of the largest. Best for salads, mild.....	.60
<b>Large Bell or Bull Nose.</b> An early variety of mild flavor .....	75
<b>Sweet Mountain or Mammoth.</b> Of large size, best for mangoes .....	.60
<b>Chinese Giant.</b> Double the size of Ruby King. This is the largest and finest mild Red Pepper. Flesh is thick and unusually mild. Productive bearer .....	1 00
<b>Long Red Cayenne.</b> Used for Pepper, sauces very pungent .....	50
<b>Chili.</b> Very piquant and prolific, fruit conical, bright scarlet .....	.60
<b>Golden Dawn Mango.</b> This is a remarkably prolific Pepper of the Bell class of a magnificent golden color .....	75
<b>Hot Mango Pepper.</b> Very Hot, best for Pepper Sauce and Pickling .....	75

The Pepper or Capsicum is valuable for its seasoning qualities, as well as for pickling. Sow early in heat and transplant when the weather is warm and settled, or sow in warm situation in the garden about the middle of May. Plants should be set a foot and a half apart.

**POTATOES**

German, Kartoffel; French, Pomme de Terre; Spanish, Petata.

<b>Houlton Stirling</b> (see novelties).	}	Prices on application
<b>Houlton Hebron.</b> White skin, the most popular variety in cultivation .....		
<b>Houlton Rose.</b> The standard variety .....		
<b>Houlton Early Queen.</b> Early and productive .....		
<b>Houlton Green Mountain.</b> Late variety, good keeper, white and mealy....		
<b>Houlton Irish Cobbler.</b> Very early, round white .....		
<b>Houlton Boree.</b> Extra early production, white flesh .....		
<b>Houlton Bagley</b> .....		
<b>Houlton Delaware</b> .....		

POTATOES—Continued

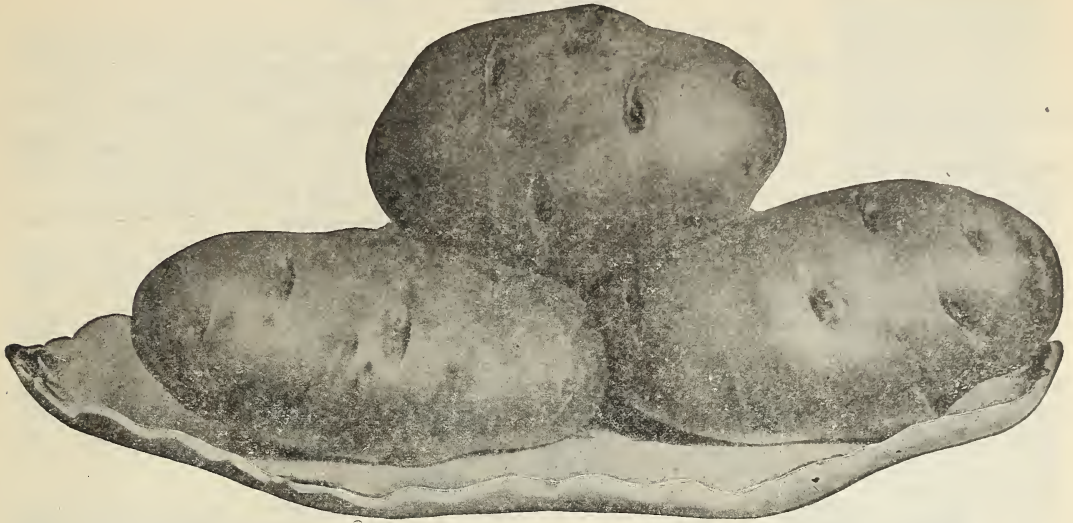

HOULTON MAINE POTATOES

PUMPKIN PACKAGE 5c.

German, Kuerbis; French, Gouge;  
Spanish, Calabaz a Tetanera.

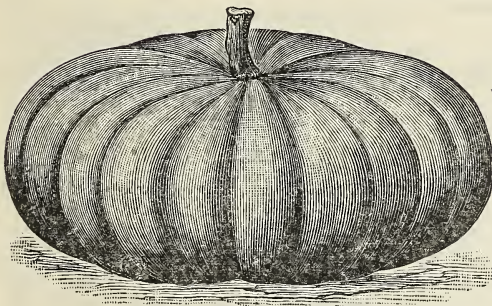

CHEESE PUMPKIN.

	Per oz.	¼ lb.	lb.
Morse's Marrow. ....	\$0 25	\$0 60	\$2 00
Calhoun. Flesh wonderfully thick, fine grained.....	15	50	1 50
Large Cheese. The best variety, hard and productive	15	50	1 50
Connecticut Field. Very productive, largely grown for feeding stock 20c. per quart, \$3.00 per bushel....	15	50	1 50
Mammoth King. Grows to an immense size .....	20	60	2 00
Early Sugar. Fruits medium size, of excellent keeping quality. Flesh very sweet	15	50	1 50

Cushaw. Salmon color, crooked neck..... 20 60 2 00

Tennessee Sweet Potato. Bell shaped, thick, white flesh, nothing finer for pies 15 50 1 75

These are unusually in fields of Corn or Potatoes, but may be profitably raised in fields by themselves. Sow in May; in hills eight feet apart.

RHUBARB PACKAGE 5c.

German, Rabarber; French, Rhuperbe; Spanish, Ruibarbo.

	Per oz.	¼ lb.
Linnaeus. Early, large and tender .....	25	75
Victoria. Very large, later than Linnaeus .....	25	75 each
Roots (Victoria) .....		\$1.50 doz

Sow early in spring, in drills a foot apart, thinning out to about the same distance apart in the rows when a few inches high. In fall or following Spring, transplant into deep, rich soil, about three feet apart each way.

**RADISH** 5c PKT.

German, Retting; French, Radis; Spanish, Robanitos.

	Per oz.	¼ lb.	1 lb.
<b>Early Scarlet Turnip.</b> The standard variety, of quick growth, mild and crisp when young.....	.15	.45	1.25
<b>Early Scarlet Turnip.</b> Forcing variety, maturing in three weeks.....	.15	.50	1.50
<b>Early Scarlet Turnip.</b> White tipped, a beautiful new early kind, round in shape; color scarlet, tipped with white, a favorite for market gardeners	.15	.50	1.50
<b>Early Scarlet Turnip.</b> White tip, forcing.....	.15	.50	1.50
<b>Olive Shape Deep Scarlet</b> .....	.15	.50	1.50
<b>French Breakfast.</b> Of quick growth, very mild and tender, of oval form; color scarlet, tipped with white.....	.15	.50	1.60
<b>Long Scarlet.</b> One of the leading market kinds.....	.15	.50	1.60
<b>Rose China Winter.</b> Flesh firm and piquant; excellent for winter use....	.15	.50	1.50
<b>White Summer Turnip.</b> A summer variety of mild favor.....	.15	.50	1.50
<b>Yellow Summer Turnip.</b> Grows to a large size.....	.15	.50	1.50



<b>Black Spanish Winter.</b> Long, one of the hardiest and best for winter use.	.15	.50	1.60
<b>Black Spanish Winter.</b> Round .....	.20	.60	1.90
<b>White Strasburg.</b> Very large, German sort....	.15	.50	1.75
<b>White Vienna or Lady Finger.</b> Crisp and tender in summer .....	.15	.50	1.50
<b>Icicle.</b> Long, pure white, suitable for forcing....	.15	.50	1.50

they thrive best in high rich soil. For a successful supply, sow from the middle of March until September, at intervals of two or three weeks. For an early supply they may be sown on a mild hotbed in February. The winter varieties may be sown from the latter part of July to the middle of September.

**SPINACH** 5c PKT.

German, Spinat; French, Spinard; Spanish, Espinaca.

Special price on lots of 10 to 25 lbs.

	oz.	¼ lb.	1 lb.
<b>Long Standing, Round Leaved</b> .....	.10	.25	.75
<b>Flander's Round Leaved.</b> The variety commonly grown, good for spring or fall sowing.....	.10	.25	.75
<b>Large Viroflay.</b> A new variety, with leaves much larger and thicker than the old variety.....	.10	.25	.75

**SPINACH—Continued**      **PACKAGE 5 CENTS**

	Per oz.	¼ lb.	lb.
Victoria, New. Dark green color, sow early.....	.10	.25	.75
Bloomsdale Savoy Leaved. A large, curled, thick leaved variety, the market gardner's favorite....	.10	.25	.75
Prickly. Prickly seeded, with triangular arrow-shaped leaves .....	.15	.45	1.25
New Zealand. Produces leaves in great abundance throughout the summer, should be raised in heat and transplanted three feet apart each way into light rich soil .....	.20	.60	2.00

Sow in fall for spring use, in drills a foot apart, thinning out the plants to three inches apart in the rows. Spinach is very hardy and does not require protection except in very exposed places, where a covering of straw or leaves is useful. For summer use sow as early as possible in spring, and at frequent intervals, during the season for succession.

**SALSIFY, OR OYSTER PLANT**      **PACKAGE 10 CENTS**

German, Bocksbart; French, Salsifis; Spanish, Salsifi.

	Per oz.	¼ lb.	lb.
Long White French .....	.45	1.25	4.50
Mammoth Sandwich Island .....	.45	1.25	4.50

This very nutritious vegetable requires the same cultivation as Carrots or Parsnips. It is quite hardy and the roots may remain in the ground all winter; a quantity can be taken up and packed in earth or sand, and stored away for use when needed. It makes a fine soup, like the oyster. It is also half-boiled, grated fine, made into small balls, dipped into butter, and fried.

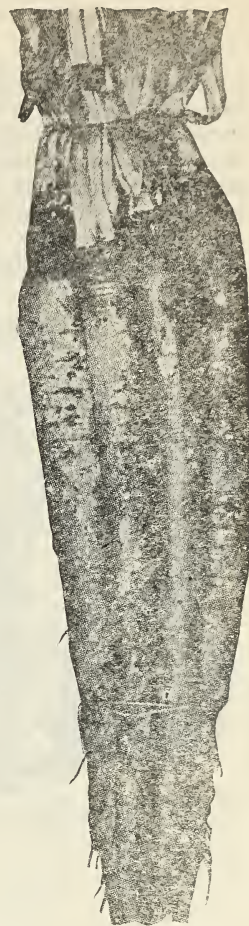

SALSIFY.

**SQUASH**

**PACKAGE 5 CENTS**

German, Garten Kuerbise, French, Courage; Spanish, Bueter.

	Per oz.	¼ lb.
Mammoth Summer Crookneck. Twice size of Summer Crookneck.....	\$0.25	\$0.75
Fordhook Squash. Bright, yellow good keeper .....	.25	.75
Early Golden Bush Scalloped. True bush growth producing fruit ready for use early in the summer.....	.25	.75
Early White Bush Scalloped. A white variety of the above.....	.25	.75
Summer Crookneck. Early, productive and of good quality.....	.25	.75
Boston Marrow. A very valuable medium early variety, an excellent keeper and of superior quality.....	.25	.75
Hubbard. The best Winter Squash, fine grained, dry, keeps well and is of excellent flavor.....	.25	.75

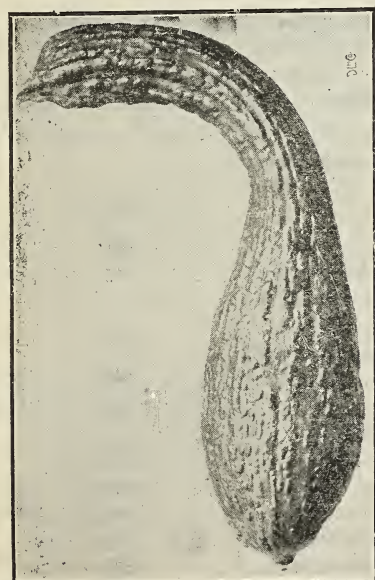

Mammoth Chili. Grows to a large size, often weighing two hundred pounds Excellent for stock .....	.25	.75
Vegetable Marrow. A favorite English sort, skin greenish yellow, flesh white, soft and rich flavor .....	.25	.75
Italian (Cocozella di Napoli) grows 20 inches long with diameter of 3 or 4 in. Green or Marbled Yellow. See Varieties.....	.45	1.25

SQUASH—Continued.

Squashes are divided into two classes, Summer and Winter. The Summer varieties come into use about midsummer, and are eaten when the rind and flesh are young and tender. The Winter varieties are left on the vines until they are thoroughly ripe, gathered in the Fall, and stored away for Winter use. If well ripened and kept in a good cellar, they can be preserved until May. Prepare hill for the seeds by incorporating two or three shovelfuls of well rotted manure with the soil, for each hill. For the bush varieties, from three to four feet each way, and for the running sorts from six to eight feet. Eight or ten seeds should be sown to each hill, thinning out after they have attained their rough leaves, leaving three or four of the strongest plants.

SWISS CHARD OR SILVER BEET. 5c Pkt.



SWISS CHARD.

**Silver Leaf.** This is a Beet producing leaves only of a quality superior to those of the ordinary Beet, and excellent greens. Cultivate about the same as spinach, by sowing in early spring in drills about a foot apart. Oz., 15c, ¼ lb. 50c, 1 lb. \$1.75.

**Giant Lucullus.** Large, crinkled leaves; tender and of fine flavor; dark green; pure white ribs. Oz., .15, ¼ lb. .50, 1 lb. \$1.75.

TOBACCO PACKAGE 10c.

**Connecticut Seed Leaf.** This variety is best adapted to the climate of the Northern and Middle States. Oz. 75c, ¼ lb. \$2.00.

**Havana.** Imported Seed, Vuelto de Abbajo. Per oz. 80c, ¼ lb. \$2.50.

TOMATO 10c Pkt.

German, Liebesapfel; French, Tomote; Spanish, Tomata.

	Per oz.	¼ lb.
John Baer. Earliest tomato grown.....	.85	3.00
June Pink. A very early market sort, smooth, medium size, bright pink	.45	1.50
Earliana, Extra Early. Bright red, smooth. It is claimed to be one of the earliest introduced, very productive .....	.40	1.40
Favorite. Large, smooth, productive, very solid and of fine flavor. A good shipper .....	.40	1.40
Bonny Best. Early tomato .....	.40	1.40
Trucker's Favorite. Large, smooth and very regular in form, purplish red, solid .....	.50	1.75
Ponderosa. Very large and solid .....	.60	2.25
New Stone. Large and smooth .....	.40	1.40
Livingston's Perfection. Very early, round, smooth, tough skin, brilliant; solid and rich flavor; ripening thoroughly. A favorite market variety..	.50	1.75
Livingston's Beauty. Large dark crimson, thick skin .....	.50	1.50
Dwarf Champion. Resembles Acme, early .....	.45	1.50
Acme. A beautiful variety. Fruit of medium size, form perfect and very smooth. Ripens all over and through at the same time. This variety seems to possess all the good qualities that can be desired in a tomato..	.35	1.30
Matchless. Extra large, smooth and handsome; bright red; very solid. Plant of vigorous growth and prolific .....	.40	1.40



**TOMATO—Continued.**

	Per oz.	¼ lb.
<b>Golden Queen.</b> A first class large, smooth, pure yellow Tomato. Fine bearer and of excellent flavor .....	\$0.75	\$2.50
<b>Yellow Plum.</b> Used principally for pickling .....	.60	
<b>Red Pear Shape.</b> Used principally for preserving and pickling .....	.60	
<b>Red Currant for Preserves</b> .....	.60	
<b>Yellow Cherry.</b> Similar to above, except in color .....		

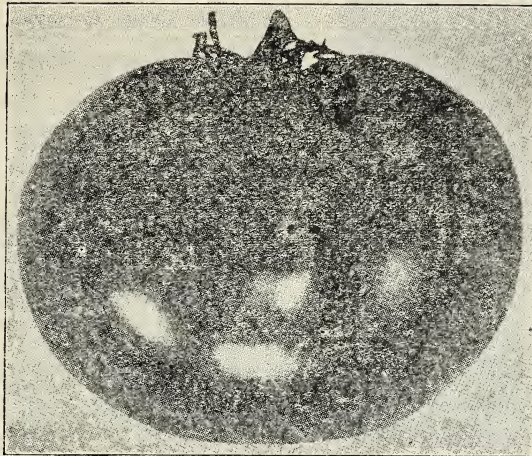

**EARLIANA TOMATO**

The seed should be sown in a hotbed about the first week in March, in drills five inches apart and half an inch deep. When the plants are about two inches high, they should be set out four or five inches apart in another hotbed, or removed into small pots, allowing a single plant to a pot. About the middle of May the plants may be set in the open ground, at a distance of three to four feet apart in hills in which a good shovelful of rotted manure has been mixed.

**TURNIP**

**5c PACKAGE.**

German, Rub ;; French, Navet; Spanish, Nabo.

	Per oz.	¼ lb.	lb.
<b>Milan.</b> (Purple top), the earliest of all.....	\$0.25	.85	3.00
<b>Early White Flat Dutch.</b> An early garden variety of medium variety size..	.15	.45	1.40
<b>Red Top Strap Leaf.</b> This and the preceding are the best two kinds for Spring sowing and for garden culture.....	.15	.50	1.50
<b>Red Top White Globe.</b> Very desirable, extensively grown for market.....	.15	.50	1.50
<b>White Egg.</b> A new variety, beautifully shaped; excellent table turnip....	.15	.50	1.75
<b>Yellow Globe.</b> One of the best for general crop, either for table use or stock	.15	.50	1.50
<b>Yellow Stone.</b> A good globe-shaped turnip, similar to the above.....	.15	.50	1.50
<b>Golden Ball.</b> A table Turnip of quick growth, and unsurpassed quality. .	.15	.50	1.50
<b>Long White or Cow Horn.</b> One of the best field Turnips, flesh fine grained	.20	.60	2.00
<b>Yellow Aberdeen.</b> Hardy and productive, large grown for farm purposes....	.15	.50	1.50
<b>Large White Norfolk.</b> Globe-shaped variety, one of the best for stock.....	.15	.50	1.50
<b>Pomeranium White Globe.</b> Very fine, white Globe variety, round and thick	.15	.50	1.50
<b>Seven Top.</b> Tops used for Greens.....	.20	.65	2.00

**TURNIPS—Continued**

**RUTA BAGAS**

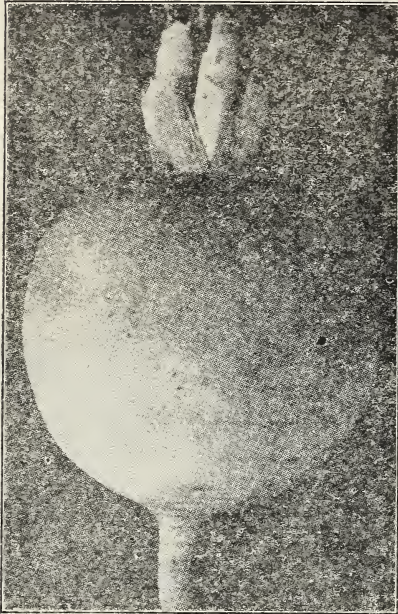

PURPLE TOP STRAP TURNIP

**American Improved Purple Top.** The leading variety, of fine quality, valuable both for the table and for feeding stock.

	oz.	¼ lb.	lb.
	.15	.50	\$1.50

**Carter's Imperial Royal Swede.** An English variety, highly recommended as producing enormous crops.

	.15	.50	\$1.50
--	-----	-----	--------

**White or Sweet German.** A large solid variety.

	.15	.50	\$1.50
--	-----	-----	--------

**Laing's Improved, globe-shaped with small top and tap root.**

	.15	.50	\$1.50
--	-----	-----	--------

For spring crop commence sowing early varieties as soon as the ground can be worked, in drills fourteen inches apart; thin out the plants to five or six inches apart. Keep clear from weeds, and when the bottoms begin to enlarge, brush away the earth from about the roots the depth of an inch or more and give them a light dressing, of wood ashes. This is the surest mode of obtaining fair and smooth Sprng Turnips in old gardens where they are almost certain to grow wormy if the earth is allowed to remain in contact with the roots. It is important to get them started very early so that they may have time to grow a sufficient size before very hot weather, when they will soon become tough and strong. For the Fall and main crops, sow from the middle of July to the last of August in drills as directed for the Spring sowing. In the field, Turnips are more generally sown broadcast though much larger crops are obtained by drill culture.

**SWEET POT AND MEDICAL HERB SEEDS**

Herbs are valuable for culinary and medicinal purposes, but they do not always receive the attention which they deserve. They are easily grown, and when preserved by drying are ready for use at any season of the year. Sow in Spring as soon as the weather is warm, and thin out as the plants grow up.

	Per oz.	Pkg.
<b>Anise</b> ( <i>Pimpinella anisum</i> ), an annual, cultivated for its seeds and its leaves, which are used for garnishing and for seasoning .....	\$0.30	\$0.10
<b>Balm</b> ( <i>Melissa officinalis</i> ), a hardy perennial, used for making balm tea and balm wine .50		.10
<b>Basil, Sweet</b> ( <i>Ocimum basilicum</i> ). This is a tender annual, cultivated for its leaves, which are much used for flavoring soups and sauces.....	.25	.10
<b>Bene</b> ( <i>Sesamum orientale</i> ) .....	.25	.10
<b>Borage</b> ( <i>Borage officinalis</i> ), hardy annual, some times used as a pot herb, and also for garnishing, but chiefly for claret cup and other cooling drinks. Bees are very partial to the flowers .....	.30	.10
<b>Caraway</b> ( <i>Carum cauri</i> ), hardy biennial, cultivated for its seeds, which are largely used in various kinds of confectionery and for giving flavor to liquors.....	.30	.10
<b>Catnip</b> ( <i>Nepeta cataria</i> ), perennial .....	.50	.10
<b>Coriander</b> ( <i>Corairndrum salivum</i> ), an annual, raised for its seeds, which are used by confectioners, and sometimes to disguise the taste of medicine.....	.10	.5
<b>Dill</b> ( <i>Anethum graveolens</i> ), annual, the leaves are used in soups and sauces, and the seeds are sometimes added to pickle cucumbers to heighten their flavor. Medicinally they are good for flatulence and colic in infants ¼ lb. .50.....	.20	.10
<b>Fenel</b> ( <i>Anethum foeniculum</i> ), hardy perennial, leaves used for garnishing, and in the preparation of various fish sauces .....	.50	.10
<b>Horehound</b> ( <i>Marribium vulgare</i> ), hardy perennial, .....	.20	.10
<b>Hyssop</b> ( <i>Hyssopus officinalis</i> ), hardy perennial, the leafy tops and flowers are used for making hyssop tea .....	.60	.10





Lawns like this can be produced by sowing Muzzy's Lawn Grass Seed

## About Lawns and Lawn Grass Seed

### FORMATION OF LAWNS FROM SEED

There is nothing more attractive than a well kept lawn.

Many things are to be considered in connection with the making and proper care of lawns. A good lawn cannot be made in one season, success coming only through intelligent care for a period of years.

The ground should be thoroughly drained and well prepared. The soil ought not to be too rich, as a rapid growth is not wanted in the grasses of a lawn; but the surface should be as much alike in quality as possible and thoroughly pulverized. After sowing, the ground should be rolled and cross-rolled in order to press the seed firmly into the soil, and ten days or so thereafter a light application of Muzzy's Lawn Fertilizer, mixed with an equal quantity of good loam or sand, will serve to stimulate the growth of the young grasses. The proper time to sow grass seed depends, of course, upon the latitude. In the central and eastern states from March 15 to the middle of May is the best time; but in favorable seasons the sowing may be done up to July 1. Seed may also be sown in the Fall, from the latter part of August to the end of September. The sowing should be done when the ground is moist, or before an expected rain, and a subsequent rolling is always advisable. As to weeds in newly-made lawns, it may not be generally known that many weed seeds actually lie dormant in the ground for six or seven years and will germinate and make their appearance when the soil is turned up. The annual wild grasses, such as crab grass or Summer grass, must be pulled up by the roots before they ripen their seed in the Fall.

**Rolling.**—As soon as the frost is out of the ground in the Spring, the land should be gone over with a heavy roller. Winter frosts loosen the soil, and rollings is necessary to compress it again. Roll frequently.

**Mowing.**—All turf-forming grasses are improved, both in vigor of root-growth and in fineness of texture, by frequent mowings. It is impossible to say just how often the grass should be mown, as that depends upon the rate at which it grows. Too close cutting should be guarded against, however, especially during the hot Summer months, when the roots require some top-growth to protect them from the burning sun. A good top growth is also necessary to protect the roots from severe Winter frosts.

It is a good plan to sow on good land, in any out-of-the-way place, strips for sod to be used for patching poor parts of the lawn, or for grass borders, etc. The best mixture of seed for this purpose is *Cynosurus cristatus* (Crested Dog's-tail). Kentucky Blue Grass and Fancy Red Top.

GRASS SEED—Continued

	Per 10 lbs.	1 lb.
<b>Hard Fescue</b> ( <i>Festuca duriuscula</i> ), admirable pasture grass of fine quality, thrives well in dry situations. 30 lbs. to the acre .....	\$6.75	\$0.70
<b>Meadow Fescue</b> ( <i>Festuca pratensis</i> ), this is excellent for hay when sown with other grasses, such as Orchard Grass and Timothy, and is also considered one of the best grasses for permanent pasture on a great variety of soils. 40 lbs. to the acre .....		Crop uncertain
<b>Sheep's Fescue</b> ( <i>Festuca ovina</i> ), does well in high, dry and open pastures, is of short, dense growth, and valuable in lawn mixtures. 30 lbs to the acre.	4.50	.50
<b>Meadow Foxtail</b> ( <i>Alopecurus pratensis</i> ), regarded as one of the most desirable grasses for permanent pasture, being early and rapid growth. 25 lbs. to the acre .....	6.75	.70
<b>Orchard Grass</b> ( <i>Dactylis glomerata</i> ), is one of the most desirable of all pasture grasses, coming early in the Spring and remaining later in the Autumn than any other. 3 bu. to the acre. 14 lb. bu. ....	5.50	.60
<b>Fancy Red Top Grass</b> , cleaned like Timothy; free from chaff .....	3.50	.40
<b>Rhode Island Bent Grass</b> ( <i>Agrotis Tennis</i> ), best of all grasses for lawn where only one variety is used .....		Very scarce
<b>Rye Grass English</b> ( <i>Lolium perenne</i> ). Probably one of the most important and valuable of the cultivated grasses; is naturally adapted to almost any soil; matures early, and is very productive, but contains less nutrition than Orchard Grass .....	2.25	.25
<b>Rye Grass Italian</b> ( <i>Lolium Italicum</i> ). This ripens much sooner than the English Rye Grass, and is greatly preferred by cattle, and greedily eaten by them, either in a green or dry state .....	2.25	.25
<b>Sweet Vernal Grass</b> ( <i>Anthoxanthum odoratum</i> ), is not valuable when sown alone, but when sown with other grasses, it becomes so because of its early growth. It also yields a delightful odor when cured for hay. 10 lbs. to the acre, mixed with other grass annuals .....	8.00	.90
<b>Tall Meadow Oat Grass</b> ( <i>Avena Elatior</i> ). As a crop to cut for hay, this is very desirable because of its early and luxuriant growth. It shoots up very quickly after being cut, and produces a thick crop of aftermath, which also makes it valuable as a soiling crop. It has been lately in demand and is much valued in the South.....	6.00	.70
<b>Timothy, Herd's Grass</b> ( <i>Phleum pratense</i> ). As a crop to cut for hay, this is probably unsurpassed. It thrives best on moist, peaty or loamy soils, and is not suited to light or sandy soils, although on such it can with care, be made to produce fair crops. Price according to market, 45 lbs. to bu....		Market Price
<b>Rough Stalked Meadow Grass</b> ( <i>Poa trivialis</i> ), produces a constant supply of highly nutritious herbage, particularly on dry soils; one of the most valuable for laying down pastures and meadows on soils either moist or moderately dry. 14 lbs. to the bushel; 20 lbs. to the acre .....	9.00	1.00
<b>Wood Meadow Grass</b> ( <i>Poa nemoralis</i> ). This grass grows well both on shady and exposed situations. 30 lbs. to the acre .....		Very scarce
<b>Tall Oat Grass</b> ( <i>Avena Edatior</i> ), good for dry pastures and meadows. Is much relished by sheep .....	9.00	1.00
<b>Golden or German Millet</b> . This variety is a heavier cropper than the Hungarian Grass, and needs a longer season and stiffer soil. Grows from three to five feet high, stands up well, is easily cured; gives general satisfaction. Three pecks to the acre. Per bushel of 48 lbs .....		Market Price
<b>Hungarian Grass</b> . A valuable forage plant, succeeds well on dry, light soil; withstands the drought remarkably, remaining green when all other vegetation is parched up, and if its development is arrested by dry weather, the least rain will restore it to vigor. Sow broadcast. Three to the acre. Per bushel of 48 lbs .....		Market Price

Prices on above subject to market fluctuations without notice.

## MEADOW AND PASTURE MIXTURES

The formation of permanent and productive meadows and pastures is of great value to farmers and has been given thorough study by numerous experts, resulting in formulas that will give good results under the varying conditions of our climate.

It is a well known fact that a heavier and more prolonged growth is produced by a mixture of many sorts of grasses than by only one or two. Some sorts do best on high, dry soil, while others prefer plenty of moisture. Some mature so early and others so late that there is no time in the season when one sort or another is not at its best. Grass seed may be sown either early in spring or fall, from September to the middle of October in this latitude. Below we give mixtures that we are confident will give good results.

### MEADOW MIXTURE FOR ONE ACRE

**No. 1. On Good Land, Neither Too Dry nor Too Wet**

Price \$12.00 for 40 lbs. (2 bushels.) Sow 2 bushels to the acre.

**No. 2. For High and Dry Land**

Price \$15.00 for 40 lbs. (2 bu.) Sow 2 bushels to the acre.

**No. 3. On Wet Land**

Price \$14.00 for 40 lbs. (2 bu.) Sow 2 bushels to the acre.

### PASTURE MIXTURE FOR ONE ACRE

**No. 4. On Good Land. Neither Too Wet nor Too Dry.**

Price \$14.00 for 40 lbs. (2 bu.) Sow 2 bushels to the acre.

**No. 5. On Dry Land**

Price \$13.00 for 40 lbs. (2 bu.) Sow 2 bushels to the acre.

**No. 6. On Wet Land**

Price \$14.50 for 40 lbs. (2 bu.) Sow 2 bushels to the acre.

### CLOVERS

(Subject to Variation in Price).

<b>Red Clover.</b> Medium ( <i>Trifolium pratense</i> ). Price variable, 60 lbs. to bushel.	} Market Price.
<b>Red Clover, Large or Pea Vine.</b> Price variable .....	
<b>White Clover.</b> ( <i>Trifolium repens</i> ) .....	
<b>Alfalfa or Lucerne.</b> Requires a deep rich soil, and in such will produce several crops every season. Fifteen pounds to the acre .....	
<b>Alsike or Swedish</b> ( <i>Trifolium hybridum</i> ). Ten pounds to the acre .....	
<b>Crimson or Italian</b> ( <i>Trifolium incarnatum</i> ), sown in Autumn, it furnishes an early fodder and is excellent for soiling. Twenty pounds to the acre. Price variable .....	
<b>Bokhara Clover</b> ( <i>Melilotus alba</i> ), affords excellent feed for bees; it is valuable soiling plant; lasts two years. Ten pounds to the acre ..	
<b>Yellow Trefoil</b> ( <i>Medicago lupina</i> ) Hop clover. Fifteen pounds to the acre .....	

## GRASS SEEDS

These Prices are Subject to Variation.

	Per 10 lbs.	Per 100
<b>Blue Grass Kentucky</b> ( <i>Poa pratensis</i> ), extra clean; does well on light dry soils; recommended for permanent pasture; it requires two or three years to form a good sod, and does not arrive at its perfection as a pasture grass until it is much older; valuable in mixtures for lawn. 14 lb bushel ...	4.50	.50
<b>Blue Grass Canada.</b> Little courser than Kentucky.....	3.50	.40
<b>Creeping Bent Grass, Florin</b> ( <i>Agrotis stolonifera</i> ), used for lawns, well adapted to most places.....	Impossible to get the seed at this time.	
<b>Crested Dogtail</b> ( <i>Cynosurus cristatus</i> ), good for permanent pasture for sheep, is productive and early, suffers but little from dry weather, and is one of the best grasses for lawns, 25 lbs. to the acre.....	5.50	.60

MISCELLANEOUS SEEDS, ETC.—Continued.

Canary, Best Sicily (Phalaris canariensis).....	Per lb.,	\$0.20	
Hemp (Cannabis sativa) .....	Per lb.,	.18	
Maw (Papaver Rhoeas) .....	Per lb.,	.25	
Lettuce Seed .....	Per lb.,	.50	
Millet (Panicum miliacedum) .....	Per lb.,	.20	
Rape (Brassica-napus) .....	Per lb.,	.20	
Mixed Bird Seed .....	Per lb.,	.20	
Sunflower, Large Russia .....	Per qt.,	.20	
Gravel for Cages .....	Per pkg., 8c	Cuttle Fish Bone.....	Each, 2c and 3c

Asparagus Roots, Conover's Colossal and Palmetto (2 years old),....per 100, \$1.00; per 1,000, \$9.00  
 Rhubarb Roots.....15c each Horse Radish Roots.....per 100, \$1.00  
 Strawberry Plants, Currant Bushes, Blackberry Bushes, Raspberry Bushes, Grape Vines and  
 Gooseberry Bushes ..... Prices on Application

QUANTITY OF SEEDS FOR A GIVEN NUMBER OF PLANTS, ETC.

Asparagus .....	1 oz. to 60 ft. drill	Pole Beans .....	1 qt. to 150 hills
Beet .....	1 oz. to 50 ft. drill	Corn .....	1 qt. to 200 hills
Carrot .....	1 oz. to 150 ft. drill	Cucumber .....	1 oz. to 50 hills
Endive .....	1 oz. to 150 ft. drill	Water Melon .....	1 oz. to 30 hills
Okra .....	1 oz. to 40 ft. drill	Musk Melon .....	1 oz. to 60 hills
Onion .....	1 oz. to 100 ft. drill	Pumpkin .....	1 oz. to 40 hills
Onion Sets, small .....	1 qt. to 20 ft. drill	Early Squash .....	1 oz. to 50 hills
Parsley .....	1 oz. to 150 ft. drill	Marrow Squash .....	1 oz. to 16 hills
Parsnip .....	1 oz. to 200 ft. drill	Cabbage .....	1 oz. to 3,000 plants
Radish .....	1 oz. to 100 ft. drill	Cauliflower .....	1 oz. to 3,000 plants
Salsify .....	1 oz. to 70 ft. drill	Celery .....	1 oz. to 4,000 plants
Spinach .....	1 oz. to 100 ft. drill	Egg Plant .....	1 oz. to 2,000 plants
Turnip .....	1 oz. to 150 ft. drill	Lettuce .....	1 oz. to 4,000 plants
Peas .....	1 qt. to 100 ft. drill	Pepper .....	1 oz. to 2,000 plants
Dwarf Peas .....	1 qt. to 100 ft. drill	Tomato .....	1 oz. to 2,000 plants

QUANTITY OF SEEDS AND PLANTS REQUISITE TO CROP AN ACRE OF LAND

Artichokes, Jerusalem .....	3	bu.	Kale, German Greens .....	3	lbs.
Asparagus, in 12-inch drills .....	25	lbs.	Lettuce, in rows; 2½ feet .....	3	lbs.
plants, 4x1¼ feet .....	8,000		Leek, in rows; 2½ feet .....	3	lbs.
Barley, broadcast .....	2½	bu.	Melon, Water in hills; 8x8 feet .....	3	lbs.
Beans, dwarf, in drills; 2½ feet .....	2½	bu.	Citron, in hills; 4x4 feet .....	2	lbs.
Lima, in drills; 4x4 feet .....	20	qts.	Millet, Pearl, in drills .....	5	lbs.
Pole, in hills, 4x3 feet .....	10	qts.	Golden, broadcast .....	¾	bu.
Beets, in drills, 2½ feet .....	6 to 8	lbs.	Mustard, broadcast .....	12 to 16	qts.
Broom Corn, in hills .....	4 to 6	qts.	Oats, broadcast .....	2 to 3	bu.
Buckwheat broadcast .....	1	bu.	Onion, in drills .....	5	lbs.
Cabbage, sown in frames .....	6	oz.	In beds for sets .....	5	lbs.
Sown in outdoor beds for trans- planting .....	10	oz.	Parsnips, in drills; 2½ feet .....	5	lbs.
Carrot, in drills; 2½ feet .....	3	lbs.	Peas Early, in drills .....	1½	bu.
Celery Seed .....	8	oz.	Marrowfat, in drills .....	1¼	bu.
Plants, 4x½ feet .....	25,000		Broadcast .....	3	bu.
Chufas, in drills, 2½ feet .....	½	bu.	Potato, cut tubers; in drills ...	8 to 10	bu.
Clover, Alsike .....	5	lbs.	Radish, in drills, 2 feet .....	8	lbs.
Red, alone .....	15	lbs.	Broadcast .....	12	lbs.
White, alone .....	12	lbs.	Pepper Plants, 2½x1 foot .....	17,500	
White, with other Seeds .....	4	lbs.	Pumpkin, in hills; 8x3 feet .....	2	qts.
Lucerne or Alfalfa .....	15	lbs.	Parsley, in drills; 2 feet .....	4	lbs.
Corn, Sweet .....	8 to 10	qts.	Rye, broadcast .....	1½ to 2	bu.
Field .....	7 to 9	qts.	Salsify, in drills, 2½ feet .....	10	lbs.
For fodder .....	3	bu.	Sorghum, in drills .....	10 to 12	lbs.
Corn Salad, in drills; 10 inches .....	25	lbs.	Spinach, in drills .....	10	lbs.
Cucumber, in hills .....	1½	lbs.	Broadcast .....	30	lbs.
Egg Plants; plants 3x2 feet .....	4	oz.	Turnips, in drills; 2 feet .....	1½	lbs.
Endive, in drills, 2½ feet .....	3	lbs.	Broadcast .....	2 to 3	lbs.
Grass, Hungarian .....	¾	bu.	Tomatoes, in frame .....	4	oz.
Lawn .....	3 to 4	bu.	Plants .....	3,800	
Orchard .....	2 to 3	bu.	Wheat, broadcast .....	2	bu.
Rye .....	2	bu.	In drills .....	1¼	bu.
Kentucky Blue .....	3	bu.	Clover, ) together ( 10 lbs. Clover		
Timothy .....	¼	bu.	Timothy, ) for ( ½ bu. Timothy		
Red Top .....	2	bu.	Red Top. ) one acre ( 1 bu. Red Top		

**GRAINS**

All grains are selected expressly for seed, and are strictly pure and true to name

Sold at Market Prices and Subject to Change

**SPRING WHEAT, 60 lb. Bushel**

**Mediterranean Spring** This variety has been grown with great success for a number of years in some sections of New England, and is very highly recommended, is bearded, yields well and the kernels are larger than those of other Spring varieties..... \$6.50 bus.

**White Russian.** This variety, recently introduced, has proved very valuable in many localities in the Northwestern States. Straw of good length, strong, does not lodge. It is not inclined to rust. Heads of large size and well filled with plump kernels weighing 60 to 63 lbs. to the bushel. Has produced 40 to 50 bushels to the acre..... \$7.50 bus.

**WINTER WHEAT, 60 lb. Bushel.**

**Red Man.** Also known as the Seneca. This is a beardless white wheat. It proves early and hardy, has a stiff straw, yields larger crops than any other..... \$5.00 bus.

**Fultz.** A beardless amber variety, grown largely in some sections of Pennsylvania and with very satisfactory results. It is very hardy and productive, and the straw is of medium length and very strong; makes excellent flour..... \$5.00 bus.

**Red Mediterranean.** (American). This is the imported variety fully acclimated and is a standard wheat. The heads are bearded and well filled. It succeeds well in nearly all localities and ripens early..... \$5.00 bus.

**OATS, 32 lb. bushel.**

**SWEDISH.** Very popular and standing well until fully ripe..... \$2.50 bus.

**RYE 56 lb. Bushel Spring \$4.50 bus. and Winter Rye \$2.50 bus.**

**SPRING BARLEY, 48 lb. Bushel**

Vermont Champion (two rowed), \$3.00 Bushel.

**BUCKWHEAT, 48 lb. Bushel.**

**Silver Hull.** This variety is a great improvement on the common Buckwheat. Sown at the same time it will continue to bloom longer, matures a few days sooner, and yields nearly or quite double under the same conditions.

**JAPANESE BUCKWHEAT**

Yields twice or three times as much as Silver Hull and ripens a week earlier.....\$3.50 bu.

**MISCELLANEOUS SEEDS, ETC.**

Cow Peas. For Fodder Per pk., \$1.75; bu., \$6.75  
Kaffir Corn or Sorghum Per lb., 15c; 100 lb., \$10.00

Essex Rape Lb., 25c; 100 lbs., \$20.00





# HIGH GRADE FERTILIZERS

## MUZZY BROS.' "SURE" POTATO PRODUCER

### ALSO FOR GENERAL CROPS

The great satisfaction this Fertilizer has given our customers, being so universal, enables us to recommend it as the Leading Artificial Manure in the Market.

#### GUARANTEED ANALYSIS

Ammonia .....	4 per cent.	
Available Phos. Acid.....	10 per cent.	Ton (12 bags) \$60.00; per bag (167 lbs) \$5.50

## MEDAL BRAND MANURE.

High grade general Fertilizer for all Crops.

#### GUARANTEED ANALYSIS

Ammonia .....	4 per cent.	
Available Phos. Acid.....	8 per cent.	Ton (12 bags) \$72.00; per bag (167 lbs) \$7.00
Potash .....	4 per cent	

## MUZZY BROS.' SPECIAL FERTILIZER

We recommend this fertilizer for a general line of crops, and consequently the trucker and market gardener is interested in buying that fertilizer which for the least cash outlay, will bring him the best returns; as it is no longer a question, but an actual fact, that from first class material, like our special Fertilizer, the purchaser will get the best results.

Equal to Ammonia.....	2 per cent.	
Available Phos. Acid.....	10 per cent.	Ton (12 bags) \$48.00; per bag (167 lbs) \$5.00

## FINE GROUND BONE

### AN EFFICIENT AND PERMANENT DRESSING FOR LAWNS; GORLESS GUARANTEED ANALYSIS

3 per cent. Ammonia.....	50 per cent. Bone Phosphate of Lime.	
5-pound bag for space 20x 25 feet.....		.50
10-pound bag for space 20x 50 feet.....		.80
25-pound bag for space 25x100 feet.....		1.50
50-pound bag for space 50x100 feet.....		2.50
100-pound bag for space ¼ acre.....		4.00
1 ton.....		68.00

## PURE PULVERIZED SHEEP MANURE

A pure, natural and nutritious manure. Immediate and lasting in effect. Excellent for mixing with the soil of the greenhouse plants. In the vegetable garden it promotes a rapid, steady growth until maturity. It makes a rich Liquid Manure.

Quantity Required. For garden and field crops. 1 to 2 tons per acre—half before plowing, the balance before harrowing. For top dressing grass; use 1 ton per acre in fall or early spring.		
Per ton of 2,000 lbs.....	\$55.00	1 lb..... .12
100 lbs. ....	3.50	5 lbs..... .45
50 lbs .....	2.00	In packages of 10 lbs..... .75
25 lbs.....	1.25	

## HIGH GRADE FERTILIZERS—Continued.

### ALPHANO HUMUS, (Chemicalized)

Decayed vegetable matter for lawn, Rhododendron, bulbs, flowers, etc. Good top dressing for the spring.

Price, per ton.....\$25.00      Per 100 lbs.....\$1.75

### NITRATE OF SODA

A fertilizer for all crops. It is very quick in action, and hastens maturity of crops fully two weeks. Being extremely soluble, it should not be applied until the crops are above the ground when 100 pounds per acre should be sown mixed with wood ashes. Does not exhaust the land.

200 lb. bag \$10.00

### ACID PHOSPHATE

14 to 16 per cent. Available Phosphoric Acid.

This is one of our Fertilizers which is used in the largest quantity in most of our mixtures as a base.

Per ton ..... \$33.00      Per 100 lbs ..... 2.50  
Per bag of 200 lbs..... \$4.00

### Pulverized Limestone

These are high calcium limes and are adapted for use on all soils that require sweetening.

Most lawns and gardens require an application of lime in some form.

The Ground Limestone is recommended for top dressing lawns and for all farm crops.

Leguminous crops such as Alfalfa, Clover, Peas and beans in particular require applications of lime.

Ground Limestone packed in 100 lb. sacks, price \$1.25; \$15.00 per ton

See next page (39).

# WHY HAUL DIRT?

YOU DONT HAVE TO  
IF YOU USE

## MICHIGAN LIMESTONE

IT IS THE ONLY AGRICULTURAL PULVERIZED LIMESTONE MADE FROM WASHED STONE

**CALCITE BRAND**

## MICHIGAN LIMESTONE

**OVER 99% PURE**



Buy Michigan Limestone and avoid paying for dirt

A BIG PROFIT FOR YOU IN EVERY TON

### MICHIGAN LIMESTONE & CHEMICAL CO., Inc.

Agricultural Lime Department

BUFFALO, N.Y.

**LARGEST AGRICULTURAL LIME MILL IN THE WORLD**

RELIABLE INCUBATORS AND BROODERS



100 and 140 Egg Reliable Standard.

Our Little Baby Grand Incubators  
50 Eggs Capacity, All Metal

Unique and superior in its construction. Beautiful in its appearance; excellent in its hatching qualities, and most Reliable and easiest operated small incubator ever offered to the trade. It has a glass window in top so thermometer can be seen without opening, and the chickens can be seen hatching without opening machine. It has a positive heat and moisture regulation and is equipped with a moisture receptacle for applying additional moisture when needed. Price \$7.50.

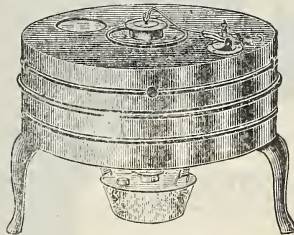

SHIPPED BY  
EXPRESS OR  
PARCEL POST

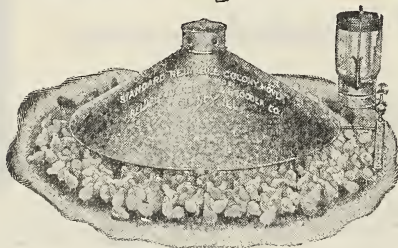

THE MODERN HOVER

This hover has the same chick capacity as the coal burning brooder. They are made in three sizes, 30 inch, 42 inch and 52 inch hover. A few of the special points on this oil heated hover are as follows:

Burns Coal Oil. No Wick To Trim. Steady Blue Flame. Abundance of Heat. Comfortable and Easy to Operate. No Oil Fumes. Visible Oil Feed. Economy of Operation. Convenient and Safe. No Coal, Smoke or Gas. The Flow of Oil Is Regulated Automatically.

0	30 inch, 250 Chicks	.....\$15.00
1	42 inch, 500 Chicks	..... 18.50
2	52 inch, 1000 chicks	..... 22.00

HOT WATER.

50-A—100 egg	\$24.75	54 —240 egg	45.00
52 —140 egg	32.50	56 —350 egg	55.00

A Double Heating System.

A unique feature of the Reliable is its double heating system—a feature possessed by no other incubator, and one which gives a decided advantage in economy of operation.

In the hot water machines there are two tanks, a hot air tank above the water tank. This tank, in addition to heating the fresh air supply, before conducting into the egg chamber, also radiates heat from its own surface, in sufficient quantity that, if necessary, the heat from the hot water tank could be cut off entirely and the hot air tank would maintain the temperature at the proper degree. This heat from the hot air tank is saved, whereas it goes to waste in other makes of incubators.

We have, therefore, a double system of heating, combining all the advantages of the hot air and water systems, overcoming all of the disadvantages of either.

OUR SPECIAL INCUBATOR

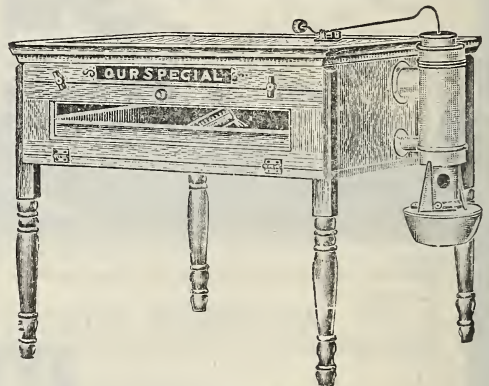

60 and 140 EGG Special

Our Special Incubator Compared with Standard Line.

Our special line is made of the same grade material as our standard, has the same regulating, the same double heating device, the same ventilating and moisture system. Our Special has all the important points for hatching that is contained in the Standard. The difference between the Standard and the Special are, the Standard has two doors, the Special has one, the Standard has lamp incased, the Special has lamp on outside at end, the Standard has nursery beneath the egg tray, the Special has none. The Standard has two wood walls, the Special 140 Egg size has one wood wall and one wall of heavy fibre board, both the Standard and the Special have the same packing between the walls, except the 60 egg size has single wood case, the Standard is 18 inches deep, the Special 9 inches deep.

No.	Size	Kind	Wt.	Price
81a	70 egg	Hot Air	36 lbs.	\$10.50
83a	140 egg	Hot Air	67 lbs.	17.00

## "Adjusto" Plant Support

is adjusted in a "jiffy" to any height, to conform to the plant's growth. It is indispensable for Tomatoes, Roses, Hydranges and Dahlias. In fact everything on the lawn or in the garden that needs a support.

The stake is made of hard wood having a protecting coat of green paint, the heavy spring wire is also painted green and so will not rust.

The price is very moderate and is within the reach of all, both large and small growers.

### PRICE

3 feet	.....15c each.....	\$1.50 per dozen
4 feet	.....18c each.....	1.75 per dozen
5 feet	.....20c each.....	2.00 per dozen

Small sizes same as above, 18 and 24 inches, suitable for small potted plants, carnations, etc.

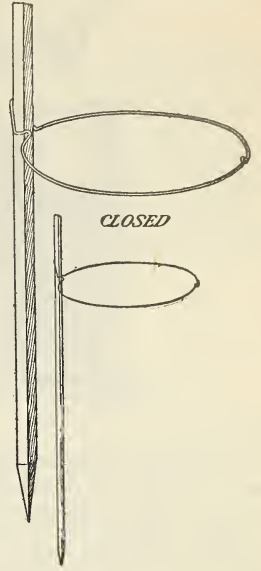
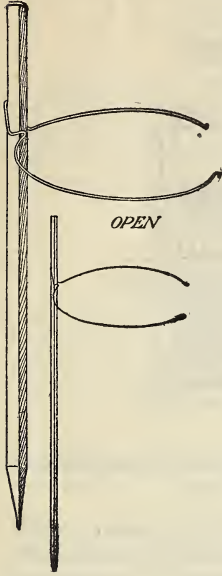

Green Dahlia Poles, 2 ft.	3 ft.	4 ft.	5 ft.	6 ft.
4c.	6c.	13c.	15c.	18c.
Bamboo Dahlia Poles, 3c.	5c.	7c.	8c.	4c.
" " " 30c dz.	50c dz.	75c dz.	85c dz.	\$1.00 dz.

### JARDINIERE FLOWER POT

Eight Day Self Watering  
(Patented 1909)



### PRICES

4 in. inside.....	each	\$0.30
5 in. inside.....	each	.40
6 in. inside.....	each	.50
7 in. inside.....	each	.65
8 in. inside.....	each	.90
9 in. inside.....	each	1.39
10 in. inside.....	each	1.75

### WIRE AND WOOD FLOWER STANDS

1 Step Wire Flower Stand, 24 inches.....	\$2.50
1 Step Wire Flower Stand, 30 inches.....	2.98
2 Step Wire Flower Stand.....	4.98
3 Step Wire Flower Stand.....	5.98
4 Step Wire Flower Stand.....	7.98

### TREE TUBS

No. 1 Round.....	\$2.75
No. 2 Round.....	3.48
No. 3 Round.....	3.98
No. 3½ Round.....	5.25
No. 4 Round.....	5.98

### FLOWER POTS.

Finest quality machine made in sizes 2 inches to 14 inches.



Indurated Fiber Rolling Stands, for large flower pots and tree tubs.

## Ornamental Fences and Gates

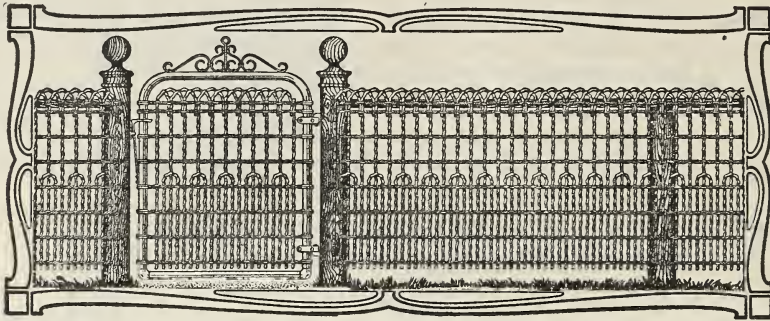

Our Ornamental Fences are exclusive in design, and embody many highly meritorious features not to be found in those of any other manufacture.

Our fabrics are made by cabling horizontal wires and inserting, at regular spaces, heavy upright or picket-wires which are corrugated either at intervals or continuously to engage the cabled line-wires, reversing the twist of the cable on each picket—thereby causing the cables to become firmly seated in the corrugations of the uprights, thus forming an immovable joint, and providing for contraction and expansion. Will not unravel when cut.

### PRICE LIST.

36 inches high.....	22c lineal foot
42 inches high .....	24c lineal foot

## PERFECTION FLOWER-BED GUARD AND LAWN BORDER

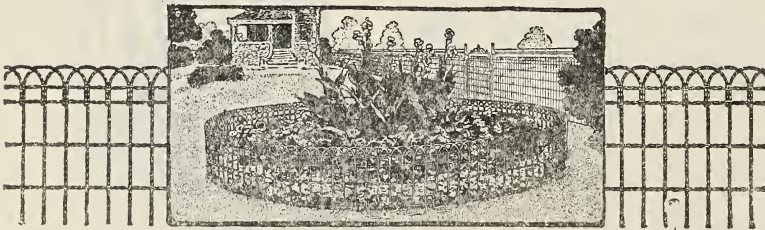

PERFECTION	
22 inches	16 inches
13c per ft.	11c per ft.

EXCELSIOR	
18c per ft.	15c per ft.

A neat, artistic, and inexpensive fabric for the protection of flower beds. Also much used for lawn and curbway border. Can be readily taken up and used from year to year, cut off to length required, and the ends hooked together when set. No posts are required to hold it in place, as the picket ends are left projecting for insertion in the ground. Uprights are of No 9 and cables of No. 13 heavily galvanized wire.

## ORNAMENTAL WALK GATES

Cyclone Ornamental Gates are made to match any of our styles of fabric. Frames are of high grade steel tubing, with fittings of high-grade malleable iron and wrought steel. Same style as above we quote: Sizes from 36 in. to 48 in. height and width. \$4.50.

**LAYING FOOD.**

**Egg Mash.**

Invaluable as a Supplementary Feed for Winter Laying—15 per cent Meat Scraps and Oil Meal—16 to 18 per cent Protein. Can be "Dry" hopper fed or moistened.

Prices on application.

**SPRATT'S CHICK GRAIN.**

A specially prepared and highly nutritious food for young chicks.

Prices on application.

**MUZZY "PIGEON FEED" A SQUAB DEVELOPER**

Right feeding of pigeons is considered something of a problem. Most raisers do not understand either the pigeon or its feeding as well as they do poultry. The true fancier, the man who raises birds for their beauty, for the show, for the pleasure there is in it, or for sporting, finds in our Pigeon Feed a combination suited to his needs.

Prices on application.

**CHARCOAL**

Prepared expressly for poultry, absolutely pure, essential to health of fowls and aids to digestion. We carry three grades:

- No. 2. Fine, for use on mash mixtures.
- No. 1 Medium, for small chicks
- No. 0 Course, for fowls, 1 lb. 10c.
- 5 lbs., 35c.      10 lbs., 55c.      25 lbs., \$1.25
- 50 lbs., \$2.25      100 lbs., \$4.25.

**GROUND BONE, Fine and Granulated.**

Ground Bone is made from the Dry Bone, and contains Phosphates, Lime and Protein and is especially valued as an egg producer.

Prices on application.

**CUT ALFALFA CLOVER.**

A Poultry Food that aids digestion and assists in the assimilation of grain foods, thereby giving better results at lower cost. Among green foods, Alfalfa stands at the top. Mealed Alfalfa is a boon to poultrymen. It is used in a mash for small chicks as well as to mature fowls. If more of this meal was fed to young chicks there would be less mortality.

Prices on application.

**CUT RED CLOVER**

Cut Clover has become the standard green food or winter egg production. It is used and recommended by every poultry expert and well-known practical poultryman in America.

Writers on poultry topics endorse it as a necessity, especially during the long winter months when the fowls are unable to obtain a substitute for the bulky green food which is so plentiful during the summer season in the shape of grass clover and vegetables.

Prices on application.

**CRUSHED OYSTER SHELLS.**

It is needless for us to enlarge on the value of oyster shells for poultry. Every poultryman realizes their importance as an egg maker and general promoter of good health.

- 1 lb. 5c; 5 lbs. 20c; 25 lbs., .60c; 100 lbs., \$1.25
- One Ton ..... 20.00

**CRYSTAL GRIT.**

We supply four sizes of grit. No. 4 for Brooder Chicks; No. 3 for Pigeons; No. 2 for half-grown Chicks; No. 1 for Hens, Turkeys, Ducks and Geese.

- 1 lb., 5c; 5 lbs., 20c; 25 lbs., 60c; 100 lbs., \$1.75

**FOUST'S HEALTH GRIT**

- 1 lb., 5c; 5 lbs., 20c; 10 lbs., 35c; 25 lbs., 75c; 100 lbs., \$2.00.

**SEEDS AND GRAINS.**

We carry a full line of the following: Wheat, Barley, Millet, Hemp, Sunflower, Kaffer Corn, Canadian Peas, Cracked Rice, Linseed Meal, Canary Seed and Mixed Bird Seed, Buckwheat, Rye, etc.

**1-2-3 POULTRY FEEDER.**

For feeding Dry Mash, Scraps, Grit, Oyster Shells, Charcoal or any poultry feed. The separator can be arranged so as you can have one, two or three compartments. When used for one kind of feed take out the separator; for two kinds put separator in one end; when used for three kinds, say scraps, shells, and grit, put separator in the middle and you have three separate compartments. Price, \$1.50.

**Gape Worm Extractor.**

The use of this instrument is so simple that a few moments' practice will give almost all information needed. The wires being flexible, may be made smaller or larger by bending to suit any age fowl.

Full directions with each instrument.

**Pilling French Poultry Killing Knife.**

Every Poultry raiser should have one of our killing knives. They are made of a finely tempered instrument steel, with nickled handle; will last a life time. Don't wait! Send for it now. Price, 50c.

**Reliable Spring Lever Poultry Punch.**

If you keep a record of your chicks, of the different breeds, hatches, strains, etc., there is no better, quicker, or easier way than by using our latest invention.

Price, 25 cents.

**Philadelphia Chick Marker**

Price, 25 cents.

**Incubator and Brooder Lamps**

With seamless founts drawn in one piece and galvanized after drawing.

7-inch by 2 3-4, No. 2 burner and chimney.

7-inch by 2 3-4, No. 3 burner and chimney.

Zero Incubator and Brooder Lamp.

Prices on Application.

**Pilling Caponizing Sets.**

The Farmer Mi Cap'niz'g Set	\$7.00
The Farmer's " "	4.00
The Philadelphia " "	3.50
The Plain " "	2.75

Full instruction for use with each set.

**High Grade Tested Thermometers.**

The best incubator or brooder manufactured is worthless unless the thermometer used therein is accurate. Hundreds of hatches in incubators fail because of inferior thermometers, and large numbers of chickens are killed in brooders owing to defective or worthless thermometers.

The thermometers here listed are thoroughly tested before they are shipped.

Incubator Thermometer, each 60c.

Brooder Thermometer, each 60c.

**Incubator Hygrometer.**

These Hygrometers should be used by every one who runs an incubator. They regulate the moisture as accurately as the heat which overcomes the trouble so many people have of chicks "dead in the shell."

Price each, \$1.50.

**Water-Glass.**

For Preserving Eggs.

1 qt. Jars	.....	.30
2 qt. Jugs	.....	.50
4 qt. Jugs	.....	.90



# The Collins Sprouter

The Most Practical, Quickest Growing

Perpetual, Sectional, Fireless

## OAT SPROUTER

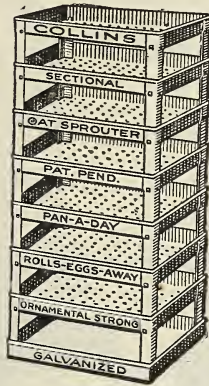

All Metal, Heavily Galvanized. Packed in Corrugated Box 11½ x 15½ inches.

### PRICES

- 5 Pans, 11 x 15.....\$3.00
- 8 Pans, 11 x 15..... 4.00
- Extra large size..... 7.00

# THE PEERLESS SELF-FEEDING DRY FOOD HOPPER



This Hopper Stands for Economy, Efficiency and Reliability.

Ideal for feeding Dry Mash, Beef Scrap, Bran, Meal, Grits, Oyster Shell, Hen-e-ta Granulated Milk, Charcoal, Cracked Bone, Whole Grains, etc. Guaranteed to give ten years of continuous service.

Hopper feeding is decidedly the easiest and most economical method of feeding birds that are being raised for breeding, for market or for egg production.

### Sizes and Prices:

- Small, 8 qt. size, for 10 to 15 birds, \$1.75
  - Medium, 16 qt. size, for 15 to 30 birds, \$2.48
  - Large, 32 qt. size, for 30 to 50 birds, \$3.25
- Buy them on our guarantee.

# This Automatic Poultry Feeder

WILL MAKE YOUR HENS LAY BETTER

The Norwich Automatic Feeder is used exclusively in the North American Laying Competitions, where all official records for high production and low mortality have been broken. The machines save half the labor of feeding, reduce grain bills, keep the fowls healthy and make them lay. You can get the same results by adopting this modern method of feeding. The new

## APACO POULTRY FEEDER

is low price, being especially designed to meet the needs of owners of small flocks. It is carefully constructed and has the all-important adjustable valve for regulating the strain flow and the positive rotary feeder rod, special features which can be secured from no other manufacturers.

Test this time-saving, results-bringing plan of feeding right now. Secure one or more Apaco Feeders and put your birds to work. They will quickly begin to pay dividends.

Guaranteed Satisfactory or Money Refunded.

Our complete catalog of money-making poultry equipment mailed free on request. It contains much valuable information which you should have.



12-Quart Size, \$1.50

Delivered.



**SANITARY GALVANIZED IRON DRINKING FOUNTAINS**  
 1 qt. Chick Fountain...40c  
 2 qt....85c 1 gal...\$1.25

**CONE TOP GALVANIZED IRON FOUNTAINS**  
 Small .....35c  
 Medium .....45c  
 Large .....55c



**LATHROP CHICK SERVER**

**THE PEERLESS BROODER FOUNTAIN**  
 The Ideal Fount for little chickens

Price 38c each, \$4.00 per dozen  
 5 qt. size 98c. 10 qt. size \$1.39  
 Heater attachment 5 qt. size or 10 qt. size, \$1.98.  
 Extra heater attachment 2 quart.....59c

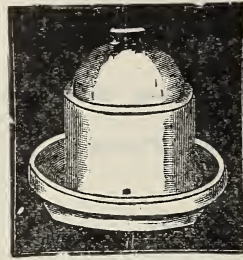

**EARTHENWARE FOUNTAIN**  
 This fountain is the only kind made in this form—2 sections—in earthenware. They can be easily cleaned; and if frozen, can be refilled without trouble. They keep the water always fresh and cool.

Each, 1 quart, 30c; ½ gallon, 40c; 1 gallon, 50c; 2 gallon, 60c.

**WALL FOUNTAIN.**

1 quart .....40c  
 2 quart .....55c  
 4 quart .....75c  
 8 quart .....98c

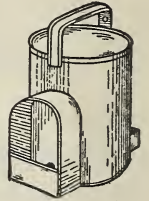

**SEXTON UP-TO-DATE FOUNTAIN**

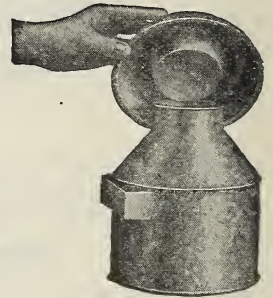

Six quarts, price 85c each

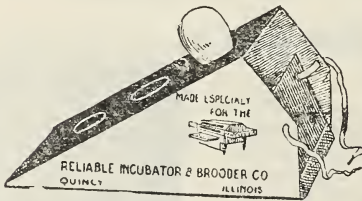

**GEM FOLDING EGG TESTER**

A tester consisting of pasteboard and a strip of mirror. The tester has been in common use for years, is very popular and fills a longfelt want for something accurate and cheap. Price, 50 cents

**KEYSTONE FOUNTAINS**

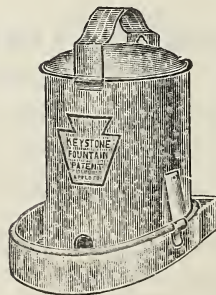

Practical  
 Convenient  
 Easy to fill  
 Not Injured by Freezing

Large comb fowls can drink readily from this fountain.

Price

1 quart .....39c  
 2 quart .....59c  
 4 quart .....75c  
 8 quart .....\$1.25

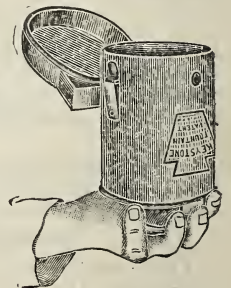

## THE NORWICH AUTOMATIC AIR-LOCK FOUNTAIN

### SANITARY NON-FREEZING

How to supply water to the poultry house during the winter months has been one of the problems which has confronted the poultrymen for years, for there is nothing more discouraging than to fill the drinking vessels, with all the accompanying discomforts of carrying water in cold weather, and then have the fountains freeze almost before we finish the task, and it has been the experience of many poultrymen that their birds have been without water for most of the day in consequence

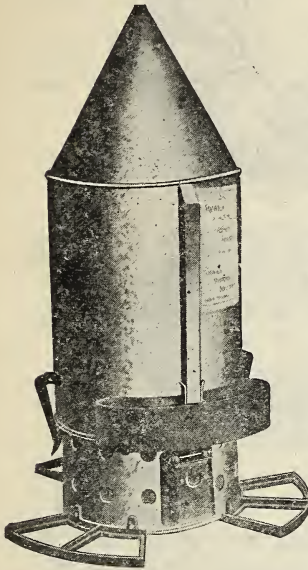

One filling of the oil tank will keep the apparatus burning day and night for two weeks, and it is but necessary to trim the wick occasionally, for the blaze is so small the wick crusting is a very slight matter. To accomplish the cleaning of the wick, the base is fitted with a slide, through which it may be attended without removing the reservoir, while the regulation for a high or low flame is accomplished from the outside of the burner by means of the wheel, as shown.

Made in one size only—5 gallons capacity.

Price—Complete with Burner Base.....\$7.00

Without Burner Base.....\$4.00

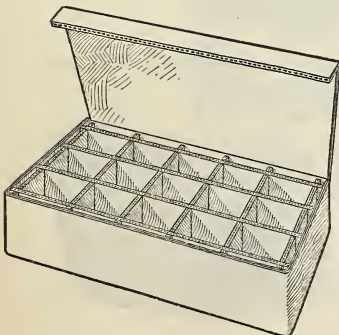

### ANDREWS' EFFICIENCY COMMERCIAL EGG CARRIER

Air cushion on all sides to prevent jars.

Eggs stand on end to prevent breakage.

Practically same as above, but made in sizes to suit shipping of commercial eggs. Printed gummed label with each carrier.

One Dozen	8 3/8-in. x 6 3/8-in. x 2 7/8-in.	\$1.25 per Doz.
Two Dozen	12 1/8-in. x 8 3/8-in. x 2 7/8-in.	1.50 per Doz.
Three Dozen	12 1/8-in. x 12 3/8-in. x 2 7/8-in.	1.75 per Doz.

### PAPER EGG BOXES

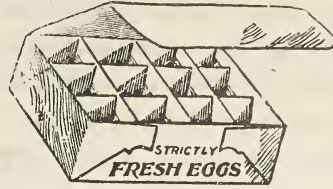

Just the thing for your family egg trade, they ship knocked down can easily be set up.

Extra heavy, 1 doz. size, 20c dozen.

\$1.00 per 100; \$9.00 per 1000

### RELIABLE EGG CARRIER

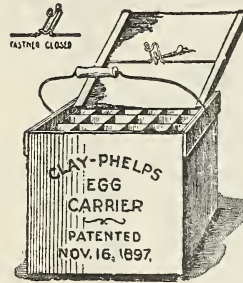

Is made with an adjustable cover and a patent combination lifter and fastener, which is far superior to other similar devices now on the market. There is no more durable or better carrier made. A necessity to all poultrymen. Prices are as follows:

8 doz. size, each..\$2.00

### LONG FOLDING PAPER EGG CARTONS

A very handy, oblong egg carton for delivering eggs. Made of good quality of cardboard; self-opening. This box can also be used for packing in ordinary egg crate, if desired.

1 doz., 25c; 100, \$1.25; 1000, \$11.00.

### EXTRA HEAVY EGG BOXES

of Manilla Board, stronger than above.

1 doz., 30c; 100, \$1.50; 1000, \$12.00.

**METALLIC EGG TESTER.**

We manufacture what is probably the neatest and surest metallic egg tester on the market. It consists of a metal lamp chimney and tubular projection. Is made in two parts so the tubular projection can be removed and chimney used separately, 35c.

**WIRE CHICKEN NESTS**

These nests are strongly made from heavy Japanned Steel Wire. They are intended to fasten to the wall with screw hooks, there is no room on them for lodgment of life, vermin of any kind, easy to keep clean and far superior to wooden boxes.

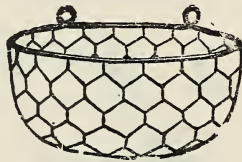

Price, each, 25c; per dozen, \$2.50.

**PIGEON NESTS**

Should be used by every pigeon fancier. Made of clay, with heavy bottom to prevent upsetting. Size about 9 inches in diameter.

Price, 20c each.

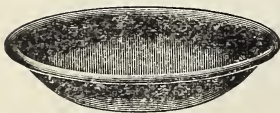
**INDURATED FIBRE**

Fills a long felt want for all squab breeders. Wood gets filthy and vermin laden in a very short time.

Iron or earthenware is cold and bad for the birds.

35c each.

**FEED AND DRINKING CUPS.**

Galvanized. Especially Suitable for Exhibition Coops.

No. 0, 43-16x3¼x2¼ inches, price, each, 25c. No. 1, 5½x3½x2½ inches, price, each \$0.30.

**IMPROVED CHAMPION LEG BANDS ALUMINUM.**

Raised Numbers

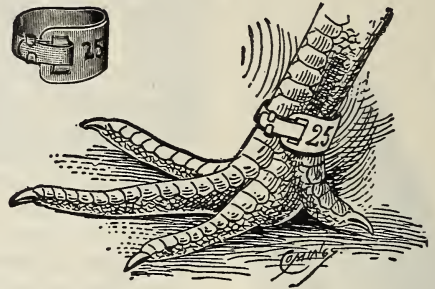

This is a well known band, is one of the best on the market; is light and strong, being held by a double lock, is impossible to come off.

15 doz; 25 for 20c; 50 for 50c; 100 for 75c.

**PERFECTO LEG BANDS.**

Celluloid.

Red, Green,

Black, Pink,

Yellow, Lt. Blue,

Amber and Ruby

Mark each hen for her pen, so that you know where she belongs at a glance.

Mark your old hens to distinguish them from the pullets so that you can catch the right one to kill at the first grab.

Price, Nos. 1, 2, 3, 15c doz., 30c for 25, 50c for 50, 75c for 100.

Pigeon and Chick, 10c doz., 20c for 25, 35c for 50, 50c for 1.00.

**ADJUSTABLE CLINCH POULTRY BANDS.**

Made of Aluminum.



Prices: 12 bands, 15c, 25 bands, 20c, 50 bands 35c. 75 bands, 50c, 100 bands, 65c.

## POULTRY-MUSTARD

The experience of practical poultry raisers and the results of careful experiments conclusively demonstrate that Colburn's Poultry-Mustard keeps fowls in vigorous condition, increases egg production, improves fertility and hatchability of the eggs, and does not injure the birds in any way.

**DIRECTION FOR USING.**—This Mustard may be fed in a dry mash or moist mash, as preferred. Give one heaping teaspoonful daily to each ten birds. This amount may be increased, especially during cold weather. Be sure to thoroughly mix the mustard with the ground grains.

Endorsed and recommended by leading poultrymen.

1½ lb Boxes, \$ .65 3 lb Boxes, 1.20 5 lb. Boxes, 1.75

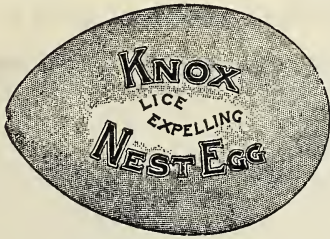

### NEST EGGS

#### ANTISEPTIC NEST EGGS.

Kills Lice and Mites in Nests and on Fowl's body where they congregate and worry the layers. No trouble to use. Simply put them in the nest.

5c each, 6 for 25c.

Lime Nest Eggs, 3c each, 30c a dozen.  
No-Odor.—One of the best nest eggs to use.

#### PORCELAIN NEST EGGS.

These eggs are made of first class flint and do not break and will last indefinitely.

Price 2c. each, 3 for 5c. Doz. 20c.

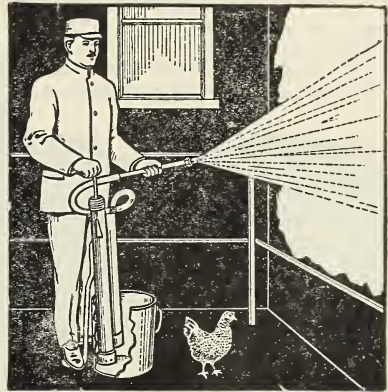

#### WHITEWASH SPRAYER

This is the only spray pump that properly sprays whitewash without clogging. It is constructed of heavy galvanized iron with brass tops and valves. Large air chamber and ball valves, the pressure maintains a continuous stream or spray not affected by the upward stroke.

Galvanized Iron, \$2.75 Brass, \$4.25

# Conkey's

THE ORIGINAL



## Buttermilk Starting Feed

Saves the lives of little chicks and keeps them growing fast

# MUZZY BROS. HOUSE PAINT



These paints are manufactured by experienced and practical workmen from compounded materials of intrinsic value as pigments, which are thoroughly mixed and ground together by improved machinery, producing a paint possessing superior durability, covering capacity and uniformity of shade.

We feel confident in stating that our Mixed Paints are cheaper to the consumer than white lead, because of their great spreading and covering capacity.

The colors are arranged on a card to show the most beautiful and durable shades for House Painting.

In general, two tints or tones of the same color produce the best effect. The body color should generally be a light tint, but for larger residences, hotels, etc., a medium color for the body, with a light tint for trimmings, will create pleasing results.

\$4.98 per gallon.

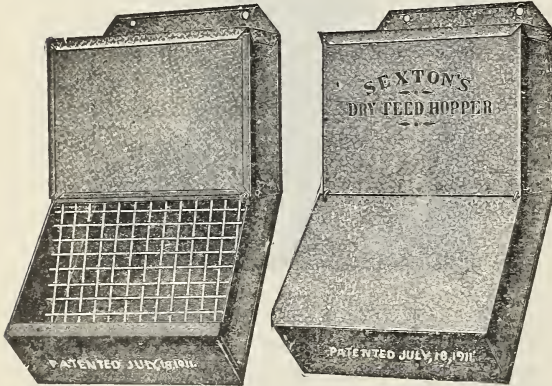

## SEXTON'S DRY FEED HOPPER

(Patent Pending)

Pronounced to be the best Hopper offered. Simple in construction, easily operated and absolutely "Rat and Mouse Proof."

- No. 1, Poultry Size.....\$1.75 each
- No. 2, Chicken Size..... 1.25 each
- No. 5, Eztra Large..... . . . . 2.98 each

Rubber Bucket Pumps and Extra Fittings

**OPEN**  
Easy to Fill  
Rat Proof

**CLOSED**  
No Waste  
Dust Proof

### POULTRY NETTING

Our Poultry Netting is woven from the best quality of steel wire of full standard gauge. It is heavily galvanized after weaving, thus insuring the greatest durability.

Galvanized Wire Netting

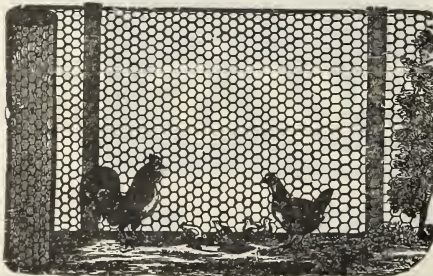

Wire 2 inch Mesh, 1 ft., 2 ft., 2½ ft., 3 ft., 4 ft., 5 ft., 6 ft. No. 20 Wire 1 inch Mesh, 1 ft., 2 ft., 2½ ft., 3 ft., 4 ft., 5 ft. and 6 ft.

Market Prices

### A WONDERFUL PROCESS OF ECONOMY

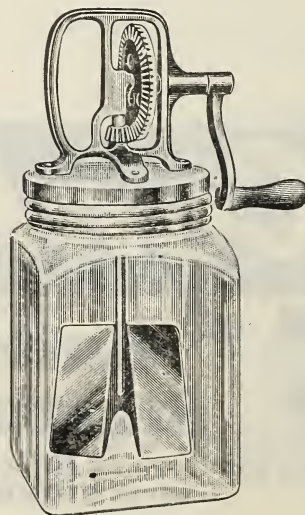

The Dazey Butter Machine saves 45 per cent. of your butter bill.

One pound of butter and one pint of milk make two pounds of milk charged butter.

#### PRICE

- 1 qt .....\$1.50
- 2 qt. .... 2.00
- 3 qt. .... 2.50
- 4 qt. .... 3.00

#### Dazey Metal Churn

- No. 100 ....\$3.50
- No. 200 .... 4.25
- No. 300 .... 5.00
- No. 400 .... 6.48
- No. 600 ... 7.48

# AQUAROID ROOFING

QUALITY CERTIFIED

ENDURABILITY GUARANTEED

GUARANTEED

1 Ply 5 Years

2 Ply 10 Years

3 Ply 15 Years

We are authorized by the Manufacturers to furnish the manufacturers written guarantee for the period above mentioned.

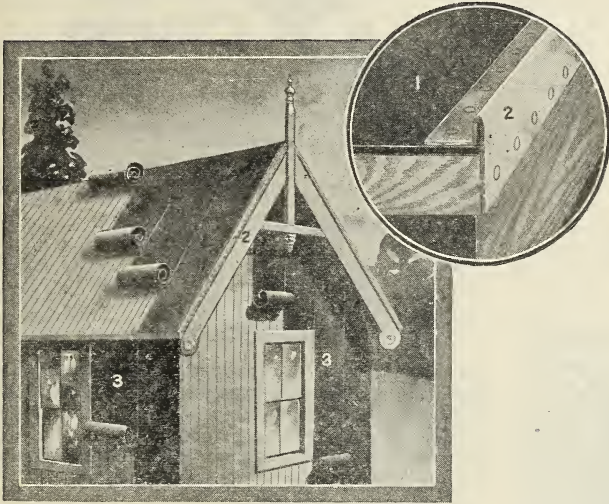

This roofing is made of the best long fibre wool felt, saturated and coated with pure refined asphaltum and is not affected by acid gases or climatic changes. It is suitable for flat or steep roofs. Put up in rolls containing 100 square feet, sufficient to cover one square allowing 2 inches for lap. Nails, tin caps, cement and directions for laying on, packed in each roll. It is made in these weights:

- 1 Ply, 35 lbs.....\$3.25 per roll
- 2 Ply, 45 lbs.....\$3.98 per roll
- 3 Ply, 50 lbs.....\$4.75 per roll

### COMPETITION ROOFING PAPER.

This paper is manufactured by a reliable manufacturer, is watertight, durable, strong, impervious to air and is not affected by heat or cold.

1 Ply, \$1.85 per roll

### MANN'S PAT BONE CUTTER

**MANN'S PAT BONE CUTTERS**  
Are one of the best Bone Cutters ever sold to the public and they are one of the most successful Hand and Power Machines on the market today for cutting green bones.

No. 5 B \$12.50 No. 5 BM with legs, \$16.00  
No. 7 with legs, \$18.50

### NO. 32 HAND MILLS

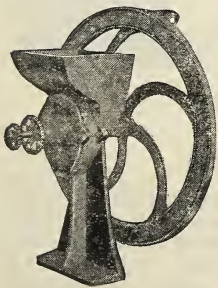

In these mills are embodied all the good features of other hand grinding mills, to which have been added universal burrs or grinding plates that are adjustable for grinding coarse or fine. This machine grinds oats, barley, rye, corn, peas, dry bone, shells, etc., for feeding to poultry. It is a well designed machine, is strong and well made throughout and of excellent finish; has a 16 inch fly-wheel and is light running.

The capacity of this mill is not equalled by any other of the same size.  
Shipping weight 40 pounds. Capacity 1 or 2 bushels per hour.  
Price. \$4.98

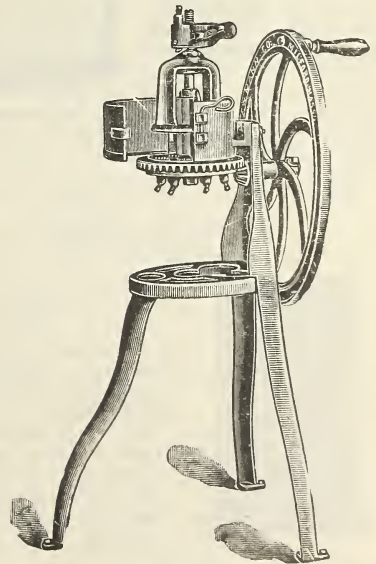

# High Grade Poultry and Pigeon Supplies

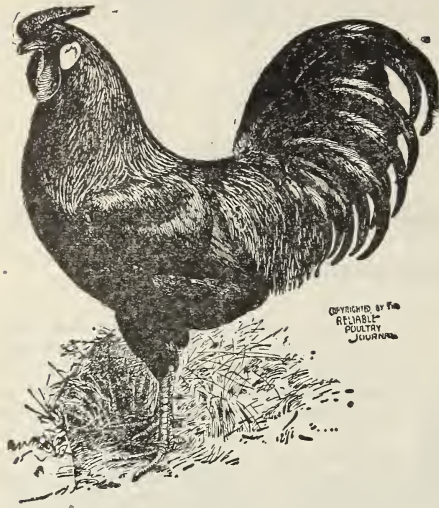

Copyrighted by the  
RELIABLE  
Poultry  
Journal

## PRATTS BABY CHICK FOOD

for the "first three weeks."

Saves the little chick—brings them through the first three weeks in fine shape—keeps them well and makes them grow fast. The most successful poultrymen all over the country testify that PRATTS BABY CHICK FOOD is the greatest money saver and chick saver that they have ever seen. If you want real success with your chicks—want to raise all that are hatched every time—use PRATTS BABY CHICK FOOD. Try it once and you will never be without it.



14 lbs. Bags, \$1.50. Packages, 30c. and 60c.

## FULL OF PEP CHICK FOOD

Feed for the Growth Stage.

A standard mixture of re-cleaned Cracked Grains, Seeds and Hulled Oats. The proportions are similar to the "Sun Brand," but a trifle coarser, especially to meet the requirements of the older chicks, although used by many from the beginning.



Prices on application.

## Conkey's Buttermilk Food

### Conkey's

THE ORIGINAL

### Buttermilk Starting Feed

### Saves Chicks

Feed it for the first 3 weeks, then follow with Conkey's Buttermilk Growing Mash and continue during the developing period. Then feed Conkey's Buttermilk Laying Mash.

Price 5 lb. pkg..... .50

Price 10 lb. pkg..... .1.00

Price 100 lb. pkg..... .8.00

## DEVELOPING FOOD.

A special food for properly maturing young chicks after they are weaned from Chick Food up to the time for feeding scratching food and laying food. Developing food is dry grain and may be fed from hoppers, but better results may be had by scattering broadcast.

Prices on application.

## SCRATCH FOOD

**For Grown Fowls.**  
Suitable at all Seasons.  
A carefully selected mixed balanced ration of grains, cracked and whole seeds, etc., adapted to the vigorous growth of fowls and production of eggs. Scratching food should be scattered in the litter the first thing in the morning and at noon; late in the afternoon feed all the mash food they will clean up.

Prices on application.

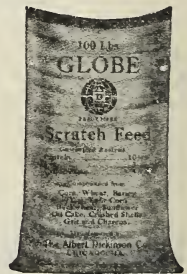

## BEEF SCRAP.

**Standard Meat Food for Poultry of all Ages.**  
High Protein Beef Scraps is an especially valuable meat food for poultry and gives very satisfactory results. Any kind of Beef Scraps will not answer. Poor beef scours the birds and often injures them, when the first is used the results are uniformly good. Do not fail to buy your supply from a reliable source.

Prices on application.



# Pratts

## POULTRY REGULATOR POULTRY REMEDIES BABY CHICK FOOD

SATISFACTION GUARANTEED OR MONEY REFUNDED

### PRATTS POULTRY REGULATOR

does make hens lay. It regulates the blood, bowels and digestive organs of all fowls. Keeps them robust and as an egg producer it stands unrivalled. When regularly used hens lay throughout the year. In fact most of such diseases as chicken cholera, gapes, roup, rheumatism, worms and egg eating are unknown when it is given regularly. 12 lb. pail, \$1.75



25 lb. pail, \$2.50  
100 lb. sacks, \$10.00  
Pkgs. 30c, 60c and \$1.20

When hens are not laying, look for lice. These pests cost poultrymen many dollars.

### PRATTS POWDERED LICE KILLER

sprinkled on hens, in nest, dustbaths, etc., will quickly clean up the poultry house. Non-poisonous; non-irritating; non-explosive. In sifting top boxes.

An unequalled powder for killing lice on horses, cattle, hogs, dogs and cats. Destroys moths, insects and bugs in houses, stables and barns. Safe and effective for killing plant-eating insects.

Packages, 15c, 30c and 60c

### HAS SAVED MILLIONS

The time to save baby chicks from white diarrhoea, the most deadly of all chick diseases, is before they get it. Begin with the first drink of water, as soon as they are hatched, and use

### PRATTS WHITE DIARRHOEA REMEDY

30c and 60c

Remember the germs are in the chicks when hatched, being transmitted from the egg. Keep the germs from becoming active, by using this remedy.



### PRATTS HEAD LICE OINTMENT

Kills Head Lice instantly. It soothes, heals and is admirable for all parasitic trouble. 30c.



### PROTECTION

Keep disease away from poultry. Kill lice and mites. Disinfect the poultry house with  
**PRATTS POULTRY  
DISINFECTANT**

A quick, effective germicide, insecticide and deodorant. As a spray around stables, cow and hog lots, and for use on dogs, cats and pets generally, it is unsurpassed for effectiveness. It is non-irritating and its pleasing, clean odor makes it admirable for household use.



Put up in Quart, Half-Gallon and Gallon Cans.

60 qt., \$1.00 1/2 gal. \$1.75 gal.  
5 gal. cans, \$7.50, 10 gal. \$13.50

### ALWAYS ON GUARD

Roup is the alert foe of poultry. Its ravages can be prevented and complete protection given your flocks by using

### PRATTS ROUP REMEDY

30c, 60c and 1\$.20  
(Tablets or Powder)

Its healing properties are quickly taken into the system, purifying the blood and killing the roup germs. It not only cures, but tones up and restores the birds to vigorous health. It is the one remedy for genuine Roup as well as colds and similar diseases.



### PRATTS SCALY LEG REMEDY

Will quickly cure this trouble and keep your birds' legs clean and healthy. 30c and 60c

### PRATTS CONDITION TABLETS

For "run down" birds. Keeps show birds in condition, prevents colds, roup and liver trouble. 30c and 60c

### PRATTS SORE HEAD (Chicken Pox) REMEDY. 25c, 30c and 60c Box.

**PRATTS BRONCHITIS REMEDY**  
for Bronchitis, Colds, etc., 30c and 60c.  
An unailing, guaranteed remedy.

### PRATTS GAPE REMEDY

30c and 60c

will effect a positive cure in chicks already attacked by gapes. Use as a preventive from the time the chicks are two days old. This remedy has our unqualified money-back guaranty.

**Pratts Baby Chick Food, See Page 41**

**ROSE NICOTINE**

Most powerful insect and parasite Destroyer known. Guaranteed to kill insects, lice on flowers, plants, fruit trees, vegetables, human body, cats, fowls, earth worms, ants, also any house bugs or vermin. 20c per pound.

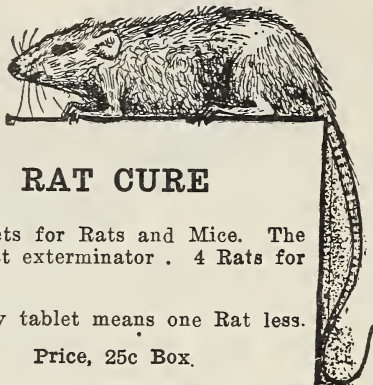
**RAT CURE**

Tablets for Rats and Mice. The cheapest exterminator. 4 Rats for 1 cent.

Every tablet means one Rat less.

Price, 25c Box.

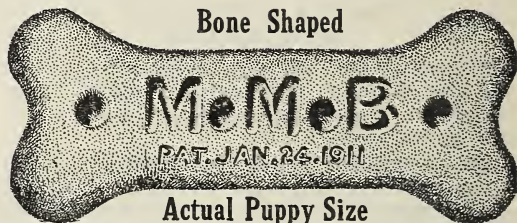
**DOG CAKES**

Bone Shaped

Actual Puppy Size

Maltoid Milk Bone is a complete food in itself and is the only Perfect Food for all breeds, the quality of which is recognized by all Dogs through their keen sense of smell to the degree that they will leave any other Dog biscuits placed side by side. We stake our reputation with you on this.

The Bone Shape is tremendously attractive to the Dogs. They will handle it exactly as a Bone, holding it between their paws, and they will gnaw at it, thus benefiting the teeth and gums, increasing the flow of saliva and aiding digestion. For these reasons it should be fed dry and unbroken.

Price, Dog Biscuits, 18c lb.

Discount in large lots

Puppy Biscuits, 18c. lb.

**SPRATT'S DOG AND PUPPY CAKES.**

Dog Cakes, 14c. lb., 5 lb. 12c.

Puppy Cakes, 14c lb., 5 lb. 12c

**Insecticides and Remedies for Plant Diseases**

**Lemon Oil-Insecticide.** This well known article is in general use all over the country for destroying Scale, Mealy Bug, Greenfly or Alphis-Ant-Thrip Caterpillar, etc. on Rose Bushes, Palms, Rubber Plants, etc. Dilute with water 30 to 50 parts.

Half pt., 45c; pt., 70c; qt., \$1.15; half gal. \$1.75 gal. \$3.00

**White Helleboro.** An excellent remedy against currant worms, rose slugs caterpillar, etc. Can be used either dry or in water,  $\frac{1}{4}$  lb. 20c,  $\frac{1}{2}$  lb. 35c. 1 lb. 65c.

**Fish Oil Soap.** One of the most effective agents used for destroying scale bug, plant, lice and all other insects, injurious to vegetation.

Price, 1 lb. box, 35c.

**Lime and Sulphur Solution for San Jose scale,** 1 gal. makes 15 by adding water.

1 qt. 45c; 1 gal. 90c; 5 gal. \$4.00;  $\frac{1}{2}$  bbl. (30 gal.) 35c; 1 bbl. (50 gal.) 30c; gal. Dry—1 lb. 50c; 5 lb. @ 38c; 10 lb. @ 29c; 25 lb. @ 25c.

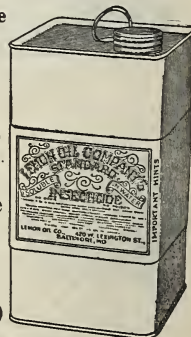
**Disinfectant  
LICE KILLER**

**GERMICIDE**

ZENOLEUM DISINFECTANT  
ANIMAL DIP.

Eight ounce can, 35c.

Quart can, 75c.

Gallon can, \$2.00.

Five gallon can, \$8.00

# THE WIARD PLOW

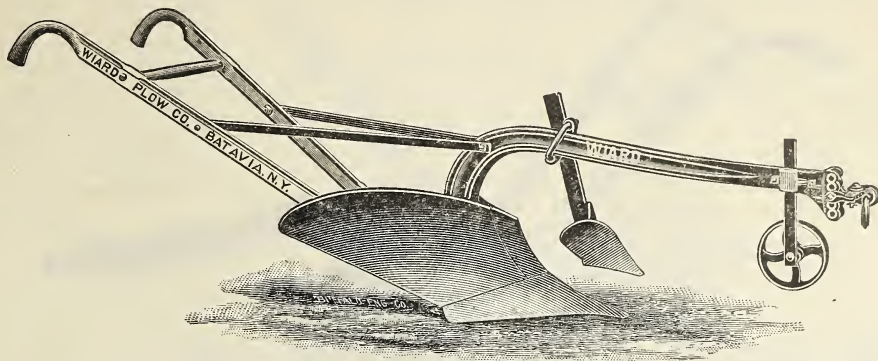

No. 604—Right hand with Chilled Moldboard, Grooved Steel Beam, light, but very strong.  
Weight, 106 lbs. Full rigid..... \$20 75

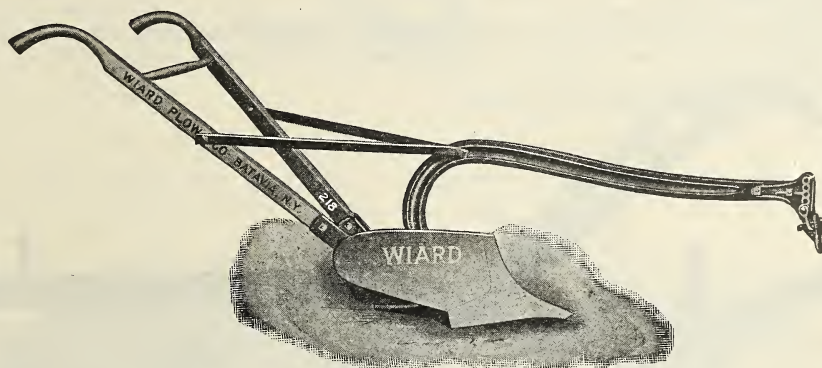

No. 218—Light Two Horse, Chilled Moldboard, Sloping Landslide, with wheel and clevis.  
Weight, 99 lbs. Price..... \$19 50

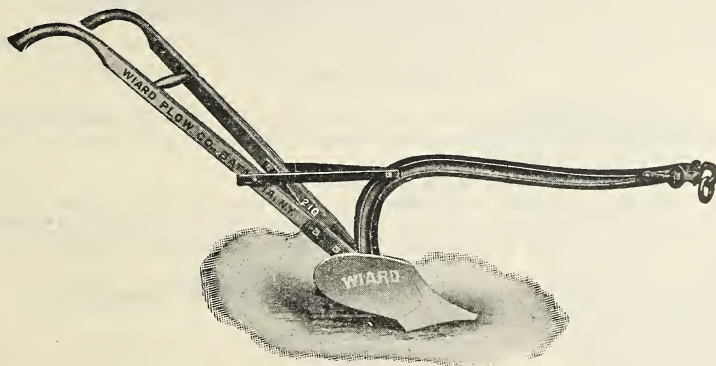

- No. 210—New 1-Horse Plow, Steel Beam, very fine with Clevis only .....\$10.00
- No. 72—Light Two Horse, Steel Beam, Right Hand, full rigged..... 24.00
- No. 62—Small, One Horse, Wood Beam, with Clevis only..... 8.00
- No. 13—Light One Horse, Wood Beam, with Clevis only..... 11.00
- No. 91—Two Horse, Steel Beam, Right hand, full rigged ..... 25.00
- No. 10—One Horse, Wood Beam, Right hand, Chilled Moldboard, Adjustable Handles for  
height and running close to rows, with Clevis only ..... 13.50

**REPAIRS FOR ABOVE PLOWS ALWAYS IN STOCK.**

- No. 115x—Swivel, Light Two Horse, Charcoal Iron Beam, Full Rigid with Adjustable Clevis ..... \$26.50  
 No. 21—Swivel, One Horse, Cast Moldboard, Wood Beam, Clevis and Wheel.. 15.00

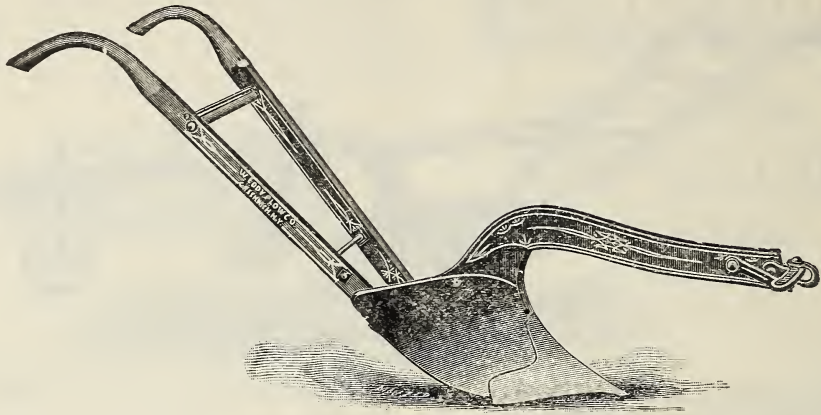

- No. 6—One Horse, Cuts 10 inches, Weight 50 lbs.....\$10.98

It has Clevis that permits horse to walk in furrow. An excellent Plow. Low in price, Chilled Iron. Landslide chilled on bottom; is very strong and convenient.

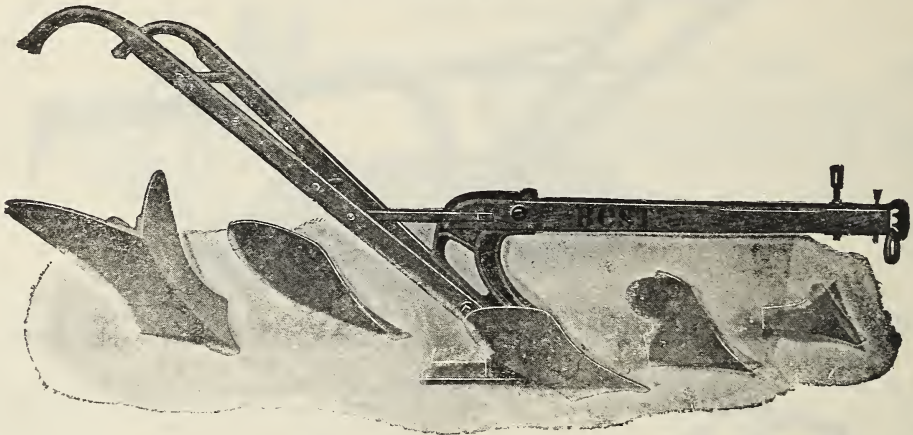

**THE BOSS PLOW.**

This is the best one horse convertible Plow ever sold for the use of market gardeners and farmers generally. By changing the Moldboards and Shears that come with the Plow, the purchaser actually has four plows in one. Price complete .....\$10.98

No. 1½ Moldboard and Share makes a large one horse Plow.

No. 2½ Moldboard and Share making a medium sized one horse Plow, a cabbage Moldboard and Share making a complete Cabbage Plow, and by using the Plow without the moldboard with the small Share bolted to the standard, makes a superior Plow for working among cabbage, strawberries, etc.

**MITCHELL POTATO DIGGER AND SHOVEL PLOW COMBINED.**

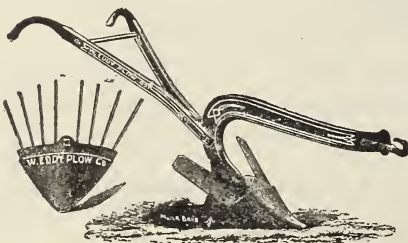

- Price with wings only..... \$9.98  
 Potato Digger..... \$6.00 extra

This implement should be in the hands of every practical farmer, doing its work easily and in the most perfect manner. By the changing of one bolt it may be converted into a Shovel Plow or Potato Digger. The fingers are adjustable, being held in position by the plow point. Thus in case of breakage, a new part may be inserted without the expense of a whole new head. The fingers, points and wings are of steel, rendering it light, strong and durable.

# Darnell's Patent Furrower and Marker

In presenting the numerous merits of this invaluable little implement we would be glad to draw a comparison with another of its kind, but we have seen or heard of nothing but the ordinary scratch sleds which made a mere mark as a guide for the plow which follows, thus increasing the work instead of lessening it.

We have a genial everbrooding neighbor, however, with whom we might compare notes, and we will just bring him forward with his plow which he is inclined to think is good enough yet. We think you will not fail to notice the difference.

We ride while he walks. We bring into requisition the services of our boy, if busy ourselves, while nothing short of a man, and a good one, too, can handle the plow.

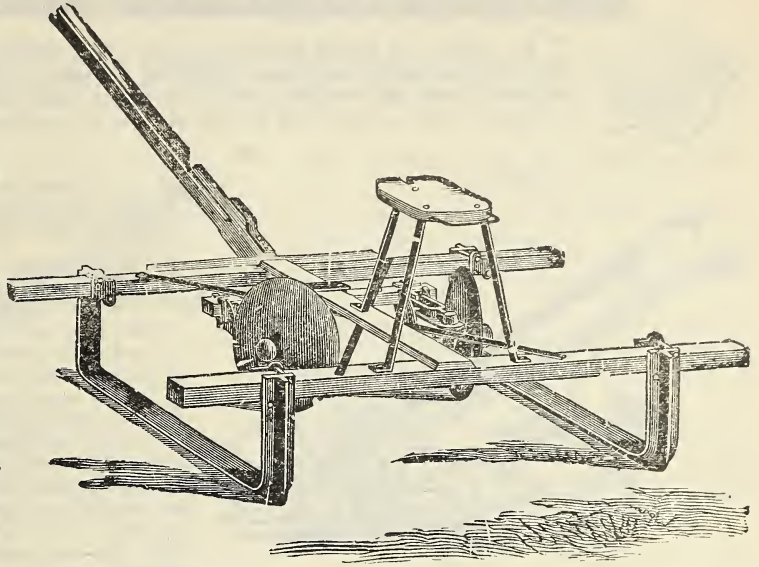

We open two furrows while he opens one in clean ground, and do it better. 5 ft. 16 in. Price, \$29.00

**THE EDDY IMPROVED MARKER**

**EDDY'S NO. 10 DISC HOE AND COVERER**

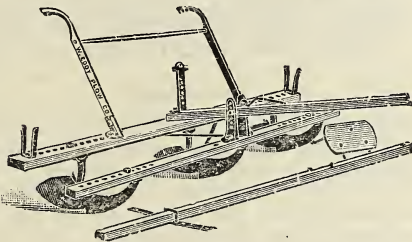

Price.....\$16.48

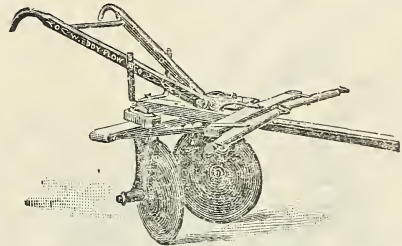

Price.....\$15.48

**THE NO. 21 McWHORTER HAND FERTILIZER DISTRIBUTOR**  
For the Practical Superior Distribution of all Commercial Fertilizers

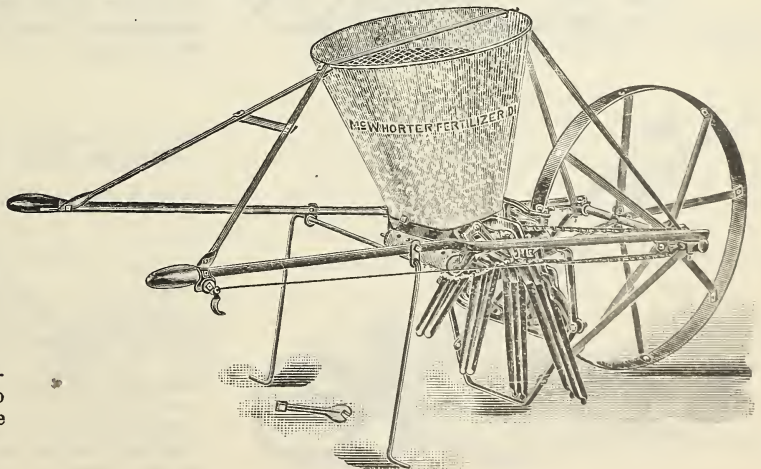

Showing Hand Distributor set for Side or Top Dressing 4 rows at one time.

Price, \$17.00

# Planet Jr. Garden Tools



The New "PLANET JR." Catalogue is the handsomest, best and most instructive book ever issued on a similar subject. Full of little points that bring profit. Full of true and handsome illustrations. We mail it free to any address on application.

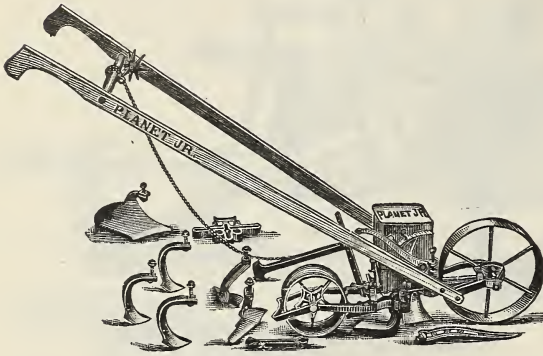

## NO. 4 PLANET JR. COMBINED HILL AND DRILL SEEDER, WHEEL HOE, CULTIVATOR AND PLOW

Price, Complete, \$21.00. Weight, 50 lbs.

As a Seeder Only, \$16.50. Holds 2½ qts. seed.

This accurate, durable and easy-running tool sows all garden seeds from the smallest up to peas and beans in hills, 4, 6, 8, 12 or 24 inches apart, or in drills at the proper thickness and depth; rolling down and marking out the next row all at one passage. No time is lost. No seed is wasted. By removing the seeder parts and substituting the tool frame, you have a first-class single wheel hoe with a set of specially hardened steel tools, the best made for hoeing, plowing, cultivating, opening furrows, hilling, etc.

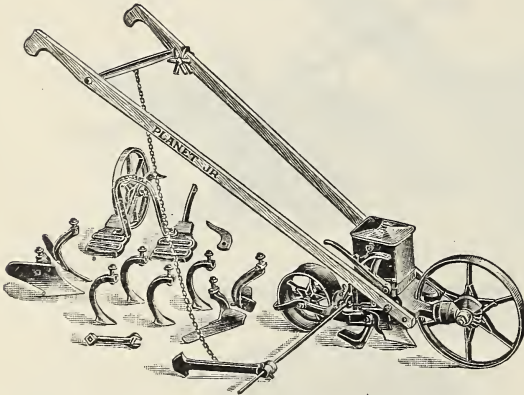

## NO. 25 PLANET JR. COMBINED HILL AND DRILL SEEDER, DOUBLE AND SINGLE WHEEL HOE, CULTIVATOR AND PLOW

Price \$23.50.

Weight packed, 61 lbs. Holds 2½ qts. of Seed

This combination is intended for gardeners who have a large enough acreage in crops for a double wheel hoe to be used to good advantage, and yet prefer not to buy seeders and wheel hoes separately; and for the family garden where a double wheel hoe is preferred.

As a seeder it is practically the same as the Planet Jr. No. 4, and as a wheel hoe has the same steel frames and cultivating attachments as the Planet Jr. No. 12 Double Wheel Hoe.

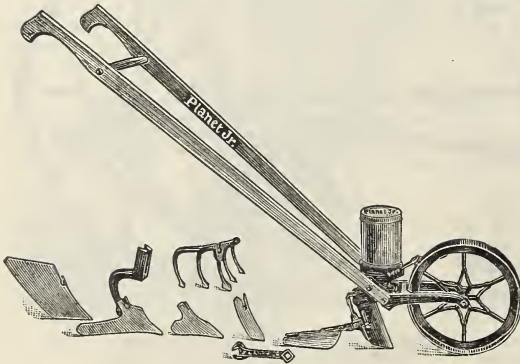

## NO. 31 PLANET JR. COMBINED DRILL SEEDER AND SINGLE WHEEL HOE

Price, Complete \$13.50 Packed weight, 30 lbs.

No. 31-D. As a Drill Seeder Only, \$11.00.

Packed weight, 22 lbs.

This new combined tool is of great value to thousands of gardeners who have never felt able to own, either a seed drill or a wheel hoe. It will sow even a small packet of garden seed with great precision in a narrow row from ¼ to 2 inches deep. Quickly changed to a splendid wheel hoe. A special machine for the small gardener at a price he can afford to pay.

# Planet Jr. Garden Tools



These Wheel Hoes are the highest type of their class. They have a great variety of attachments which adapt them to a large variety of work, and there is scarcely any garden cultivation they will not do.

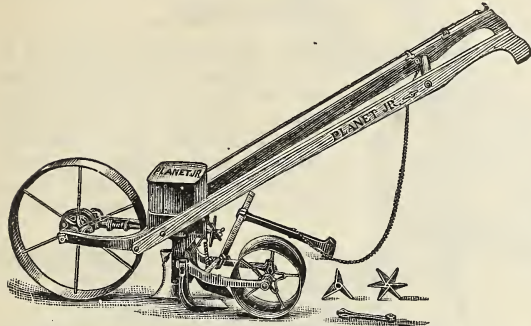

Holds 3 qts. of Seed. Weight, packed, 43 lbs.  
Price, \$19.50.

## NO. 3 PLANET JR. HILL AND DRILL SEEDER

A favorite among onion growers, market gardeners and seedsmen.

The 15-inch driving wheel is steel, with heavy forged spokes, making the tool light and easy running.

The opening plow is V-shaped, adjustable for depth, leaving the seed in a very narrow line, making close cultivation easy. The index is in plain view at top of handles and graduated for hills or drills.

The flow of seed is instantly started or stopped by the cut-off rod. No seed wasted at end of rows. Sows in large or small quantities in drills or in hills, 4, 6, 8, 12, 24 inches apart. Force feed.

## NO. 12 COMBINED DOUBLE AND SINGLE WHEEL HOE, CULTIVATOR AND PLOW

Straddles crops till 20 inches high, then can be worked between rows with one or two wheels.

The hoes are wonderful weed killers and leave the ground almost level. The cultivator teeth are of improved design and admirable for deep work. The plows are invaluable for opening furrows for manure, etc.; for covering and for plowing to or from the crop, \$13.50.

## NO. 13 DOUBLE AND SINGLE WHEEL HOE

Price, \$9.50. Weight, 28 lbs.

This tool is the No. 12, with 6-inch hoes only, these being the tools that are most used.

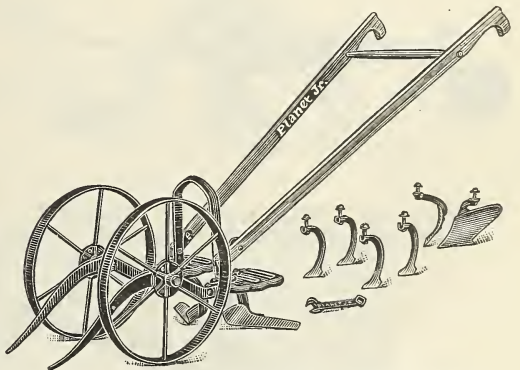

No. 12. 14-inch steel wheels. Steel frame.

Price, \$13.50. Weight, 33 lbs.

## NO. 16 PLANET JR. SINGLE WHEEL HOE, CULTIVATOR, RAKE AND PLOW \$11.00.

Nos. 16, 17, and 18 have the same steel wheels, frames and handles, but the attachments sold with each vary.

The handles are adjustable in height. The frame is steel, convenient and strong with quick change device by which to exchange the tools without removing the nuts.

## NO. 17 PLANET JR. SINGLE WHEEL HOE

Price, \$9.25. Weight, 24 lbs.

The No. 17 has a pair of 6-inch hoes, a plow and a set of cultivator teeth, an outfit sufficient for most garden work.

## NO. 18 SINGLE WHEEL HOE

Price, \$6.40. Weight, 19 lbs.

This has one pair of 6-inch hoes only—the tools that are most constantly useful throughout the season.

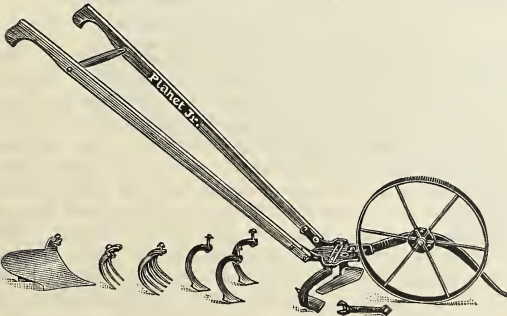

No. 16. Price, \$11.00. Weight 26 lbs.  
Steel Frame. 15-inch Steel Wheel.



# Planet Jr. Tools



No other cultivating machine is so widely known as the Planet Jr. Combined Horse Hoe and Cultivator, for it is in use throughout the civilized world. It is so strongly built as to withstand incredible strain, yet it is light and easy to handle.

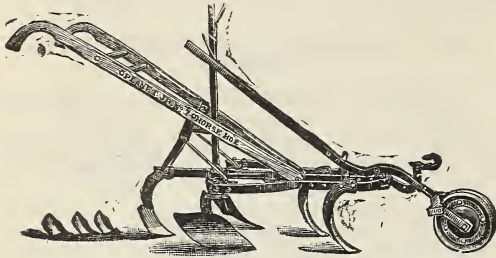

Price \$20.50. Packed weight, 77 lbs.

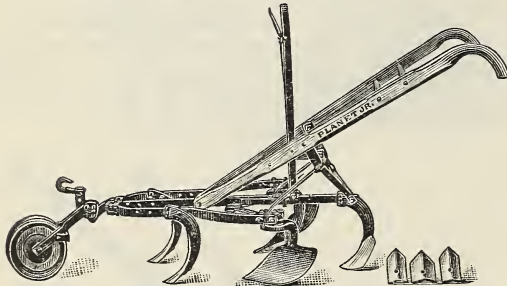

Price with Steel Wheel, \$18.50.

## PLANET JR. TWELVE-TOOTH HARROW, CULTIVATOR AND PULVERIZER

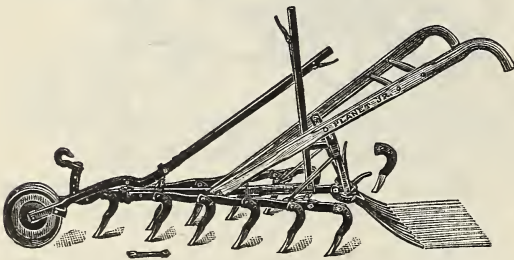

No. 90, Complete, with Steel Wheel. \$21.50

Weight, packed, 74 lbs.

No. 90-B, Without Pulverizer, \$18.00

No. 90D, Without Pulverizer or Wheel, \$13.50

No. 91, With Steel Wheel, \$15.00

Gardeners cultivate better than formerly and find it pays. The chisel-shaped teeth on this tool go as deep or shallow as you like, close to row, without injuring plants, cut out all weeds, stir the soil and mellow and fine it as with a garden rake. Any width from 12 to 32 inches. A special favorite with strawberry and tobacco growers, market gardeners, truckers and small fruit growers.

## NO. 7 PLANET JR. COMBINED HORSE HOE AND CULTIVATOR

Steel Wheel.

Opens and closes furrows, hoes right up to the plants without danger of injury, throws dirt to or from the row and throws back from centre again. Adjusts for any width. The teeth, made of beveled steel, specially hardened, retain their cutting shape and out-wear anything made. The steel wheel won't clog. The handles adjust up, down or side-wise.

## NO. 9 PLANET JR. COMBINED HORSE HOE AND CULTIVATOR

Weight, packed, 70 lbs.

This Horse Hoe is identical with No. 7, except that it has a plain wheel instead of lever wheel. It has the high frame, patented hollow steel standards, steel wheel, patent lever expander, and hollow steel wheel arms.

This tool has become popular because of its strength and lightness, easy change of width, and while not so handy as a tool with a lever wheel, it is a favorite.

The New Steel Wheel, having no spokes, will not clog with corn stalks, stones or other trash, and little or no sand or dirt can be carried up on the inside of the rim to drop on the bearings.

## No. 101 PLANET Jr. COMBINED HORSE HOE AND CULTIVATOR.

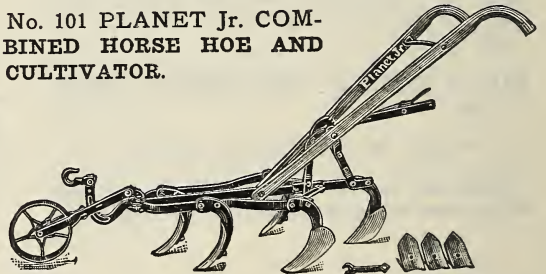

Price \$13.35. Weight, packed, 60 lbs.

This admirable tool is new for 1916. The expander lever, instead of standing perpendicular, slants backward between the handles, so it can't get bent or broken, and won't injure crops under cultivation. Its weight adapts it particularly to use in light land, but it is strong enough for use everywhere, and is so simple in construction and has so few parts, it can't get out of order. The cultivator teeth are made of high carbon, beveled steel, and will retain their shape. The turning shovels are of special design, of elegant proportion and useful in connection with the shovel steel in throwing furrows, and afterwards covering them, and for plowing and hilling much or little as desired.



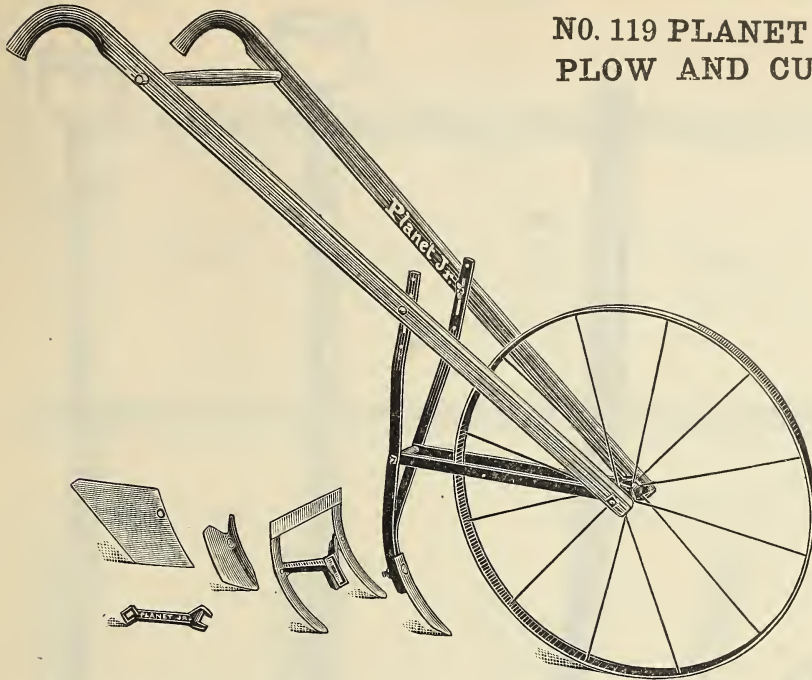

**NO. 119 PLANET JR. GARDEN  
PLOW AND CULTIVATOR**

This new member of the "Planet Jr." family will appeal to all those who prefer a high wheel tool for their garden work. Where the soil has not been so thoroughly and carefully prepared, the high wheel undoubtedly makes an easy running tool.

**PRICE \$5.50**

Weight 16½ oz.

**National Fence**



National Farm Fence, 45-inch, Price, per Rod (by roll) 70 cents.  
National Farm Fence, 32-inch, Price, per Rod (by roll) 60 cents.

**NEW NATIONAL POULTRY FENCE**

48-inch, Price per Rod (by roll) .80      58-inch, Price, per Rod (by roll) .85  
**NEW RABBIT FENCE**  
58-inch (No. 2158) 6-inch Stays.....90c Rod



Six Tine Manure Fork, Strapped, \$1.75



Five Tine Manure Fork, Strapped, \$1.48.



Four Tine Spading Fork, 1 Strapped, \$1.10



Five Tine Spading Fork, Strapped, \$1.85.



Two Tine Hay Fork, 4 1-2 ft. Handle, 40c.



Three Tine Hay Fork, 5 ft. handle, Strapped: 75c. 5 1-2 ft. handle, Strapped, 80c.



Four Prong Weeding Hoe, Malleable....40c

Six Prong Weeding Hoe, Malleable...45c



One Prong Onion Hoe.....40c

Two Prong Onion Hoe.....40c

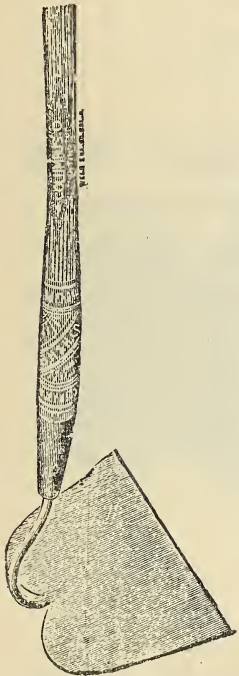

Socket Field Hoe,  
Riveted .....45c



Four Prong Potato  
Hook, heavy \$1.50

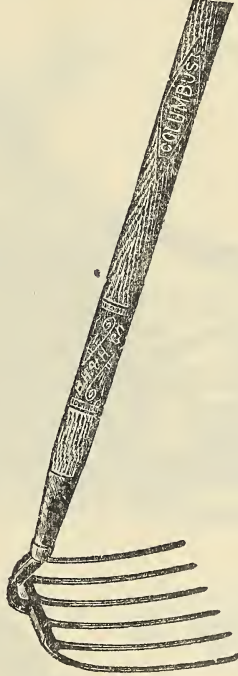

Six Prong Potato  
Hook .....\$1.25



Four Prong Potato  
Hook .....98c

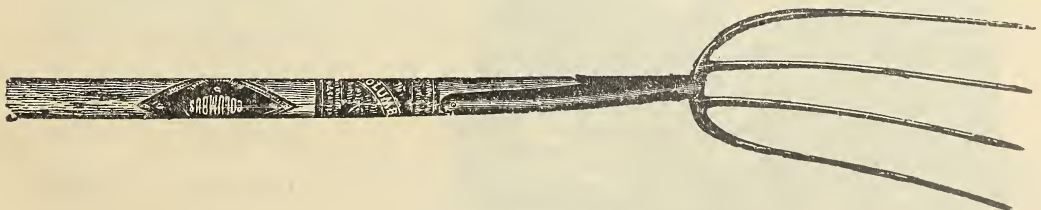

Four Tine Manure Fork,  
Strapped Long Handle, 98c

# LAWN MOWERS

Tip Top Mower

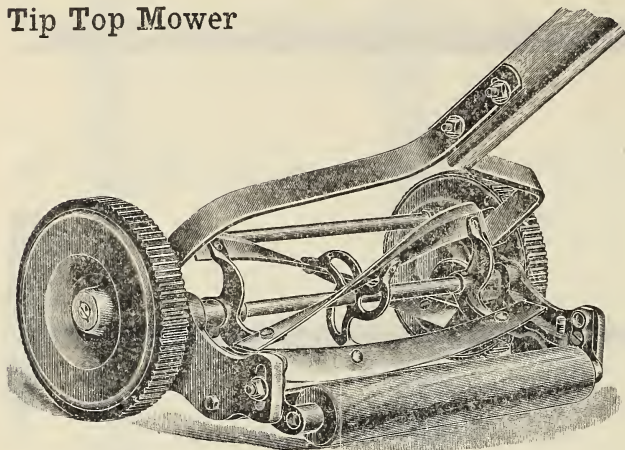

## TIP TOP MOWER

Our Leader

Best Mower for the Price

12-inch . . . . \$5.50

14-inch . . . . 6.00

16-inch . . . . 6.50

New England Mower  
Ball Bearing

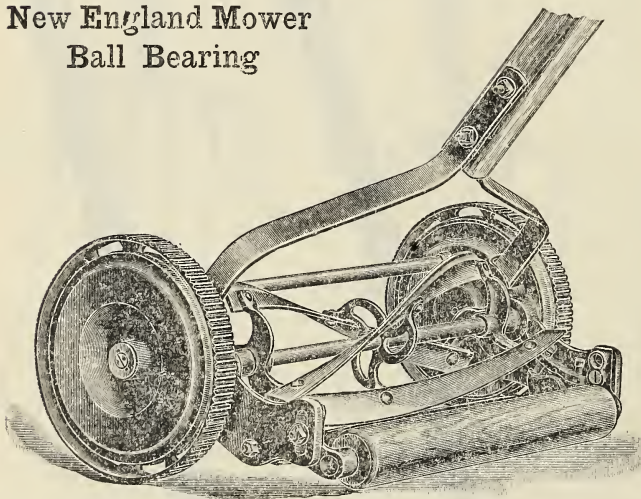

## New England Mower.

Ball Bearing

A High Grade Mower

Sold at a Low Price

14-inch . . . . \$6.50

16-inch . . . . 7.00

18-inch . . . . 7.50

Wizard Mower  
Ball Bearing

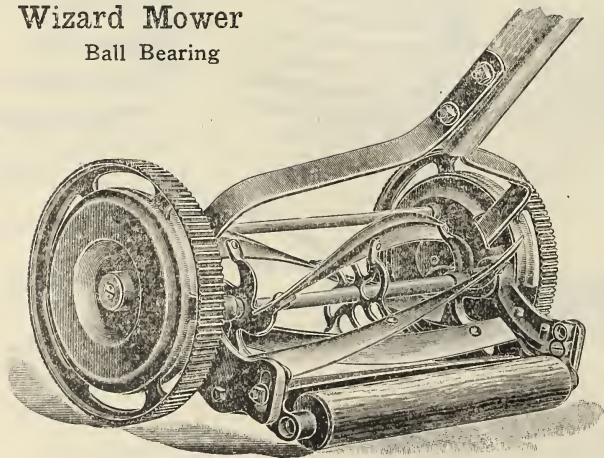

## WIZARD MOWER

Ball Bearing

Strictly High Grade

14-inch . . . . \$8.00

16-inch . . . . 8.50

18-inch . . . . 9.00

# The Philadelphia Line

## Paterson Mower

12 inch .....	\$5.00
14 inch .....	\$6.50
16 inch .....	\$7.00

## Muzzy Mower

14 inch .....	\$7.50
16 inch .....	\$8.00
18 inch .....	\$8.50

## Muzz High Wheel

14 inch .....	\$10.00
16 inch .....	\$11.00
18 inch .....	\$12.00

## Independence Roller Bearing

14 inch .....	\$12.00
16 inch .....	\$13.50
18 inch .....	\$15.00

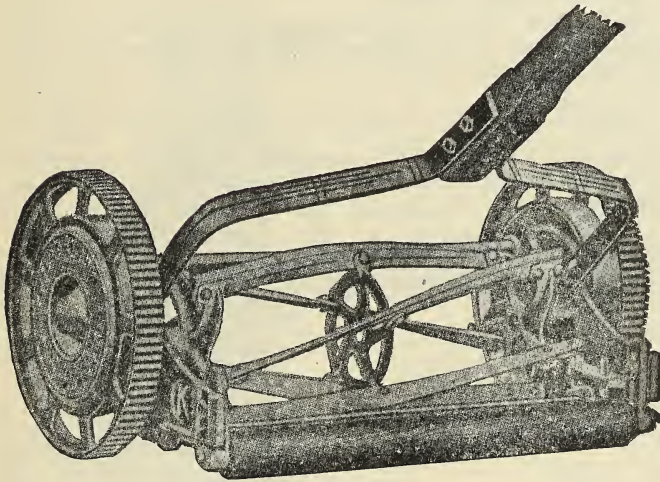

## Style K.

5 blades, 10 inches wheel.

Bes. Mower made

Prices:

14 inch ...	\$16.00
16 inch .....	\$17.60
18 inch .....	\$19.20
20 inch .....	\$20.80

## LAWN TRIMMER

For trimming around walks, flower beds, trees, posts, monuments and shrubbery, and all places that cannot be reached with any lawn Mower.

Cuts within  $\frac{1}{4}$  of an inch of the edge.

Price, \$8.00

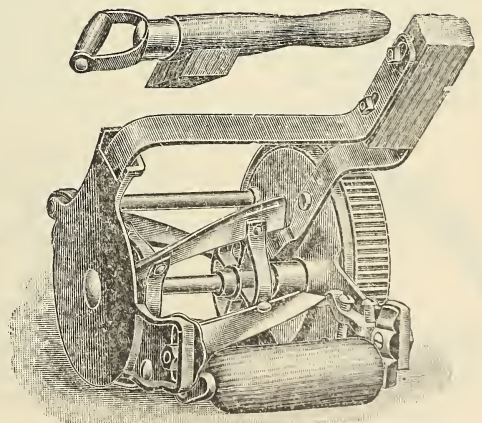

## RAKES AND SCYTHES

### LAWN RAKES

- 3 Bow Lawn Wire Bow.....\$0.60
- Wire Lawn Rakes ..... .75
- 3 Bow Lawn Wood Bows. .... .70



- 10 Tine Malleable Rake.....\$0.38
- 12 Tine Malleable Rake..... .40
- 14 Tine Malleable Rake..... .45

	Plain	With Bow Brace
12 Tine Cast Steel Rake....	\$0.80	\$0.95
14 Tine Cast Steel Rake....	.85	1.00
16 Tine Cast Steel Rake....	.90	1.05

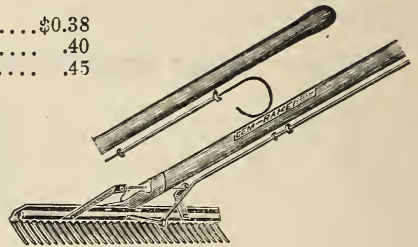

### GEM DANDELAWN RAKE.

is a perfect dandelion exteminator. The curved teeth, riding along on the sod, just catch the heads and clip them off. The grass is not torn up, as by ordinary rakes, and the juncture of the teeth, though sharp enough to cut the stalks, does not permit them to jam and clog up the implement.

Dandelions come up between mowings. It is not necessary to cover the whole lawn to get them with a Dandelion Rake.

When a lawn mower is used to destroy dandelions, it is necessary to rake up the heads afterward. That means—if an ordinary rake is used—constant bending over to clean off the accumulated litter, from which seeds drop on the s oil.

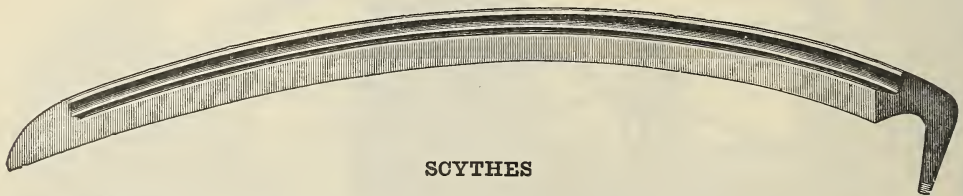

### SCYTHES

- Blood's Ribbed Back. Nothing better..... \$1.75
- Blood's Plain Back, Polished..... \$1.75
- English Lawn. An elegant tool for fine work..... 2.75
- Bush Scythes. For rough work..... 1.75
- Snaths. Patent, Plain and Bush, Scythe Stones and Rifles in variety.
- Floral Sets, consisting of Hoe, Spade and Rake .....15c, 25c 39c 75c 1.00
- Trowels .....5c, 10c, 15c, .25
- Strawberry or Pruning Forks.....5c, 10
- Fruit Pickers. Do not bruise fruit..... .40
- Excelsior Weeder ..... .15
- Grafting Wax ..... ¼ lb., 15c; ½ lb., 25c; 1lb., .40



Grass Hooks 35c and 50c.



**Pruning Shears**  
50c, 75c, 98c and \$1.50  
Dibble, Iron or Wood  
handle .....40c and 45c  
This tool is indispensable  
for planting small roots and  
plants; once tried the gar-  
dener will never dispense  
with it.



Garden Syringe, 98c and up.



Pruning Saws .....98c.

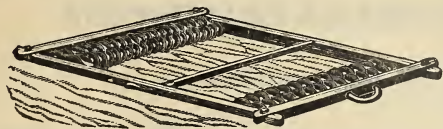

**THE MEEKER SMOOTHING HARROW.**  
Perfect Harrow and a Perfect Land Roller Combined.

This harrow has become a great favorite among all classes of farmers and market gardeners in all parts of the country.

It has two sets (four) of rollers containing 58 steel disks.

These disks grind all lumps and save the work of raking, and also mash small stone below the surface better than any field roller, leaving the land smooth and level.

The disks of one roller work between those of the other, preventing clogging in damp soil. The board in the center is set at an angle, is adjusted up or down and serves as a leveler.

Regular size, 6 ft. 8 in. by 6 ft. with 8 in. disks, \$32.50. Weight, 200 lbs.

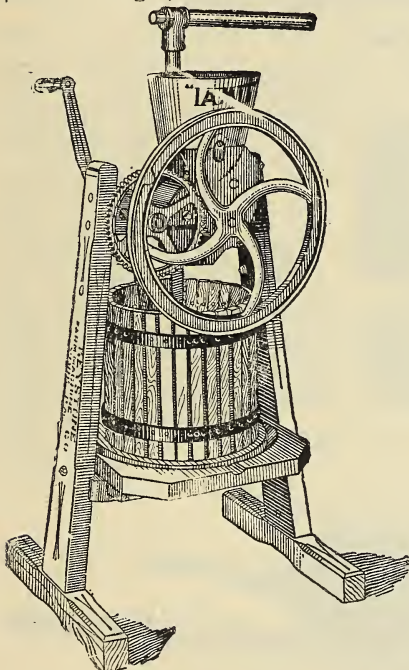

**APPLE AND GRAPE GRINDERS**

- No. 11 .....
- No. 22 .....
- Wizard .....

Prices on Application

- Junior .....
- Medium .....
- Senior .....

Prices on Application

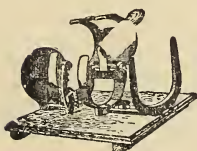

**ACME ASPARAGUS BUNCHER.**

A greatly improved pattern with knife guide and adjustable head piece for regulating the length of the bunch. This is the latest pattern, 1907 patent.

Price .....\$3 00

**5 PRONG**

**Cultivator-Hoes and Weeders**



are among the most modern tools for garden and flowers. They are light and strong and cultivate closer to plants without injuring them than any other kind of implement, leaving the soil level, loose and untrampled.

Cost but little more than the common hoe—accomplish much more and better work with less labor. \$98

**TREE GUARDS.**

Made 6 feet high of heavily galvanized wire, in 8 1/2 and 12 inch diameters. \$1.75., \$2.00 \$2.50.

Ready for setting up by clasping the hooked ends. Furnished with spiral spring, which attaches to tree and prevents rubbing or bruising of the bark. Protects without shading or otherwise injuring the tree.

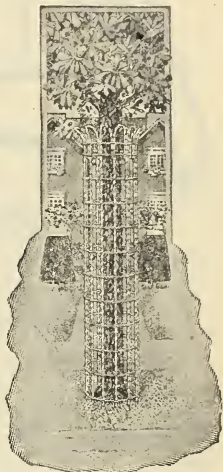

**THE "I AM IT" CIDER MILL.**

A combined Mill and Press with geared cylinder, and adjustable concave, so that grinding can be done, as desired either coarse or fine. It will grind apples at the rate of one-half bushel per minute. It is a Self Feed—you need not poke the apples to the grinding disc.

**Price on Application**

**Cider Presses.**  
Diameter of Tub.

- No. 1 10-in.....
- No. 2 12-in.....
- No. 2 1/2 in. 13 1/2 in.....
- No. 3 15-in.....

Prices on Application

**CIDER MILLS**



## CYCLE BALL-BEARING STEEL FRAME GRINDSTONE



Solid Steel Frame with Seat

Stone 19 to 22 inches, 2 to 2¼ inches thick. Best Quality Berea Grit. Front legs formed of one piece heavy steel angle. Rear legs formed of one piece heavy steel angle. Upper frame is constructed to form a brace for legs, making most rigid frame possible. Built on up-to-date mechanical principles.

Weight 85 lbs.

Price Richards Cycle.....\$6.50

Price with Pipe Frame.....7.98

## RURAL GEM NO. 4, With Self-Closing Door

Approved by Postmaster General

### Description

Made from 22-ga. galvanized steel; absolutely storm-proof; the door is hinged at the bottom and yet is kept constantly closed by a spring hinge—cannot carelessly be left open nor blown open by the wind; has a large flag, visible for a long distance and easily operated; has

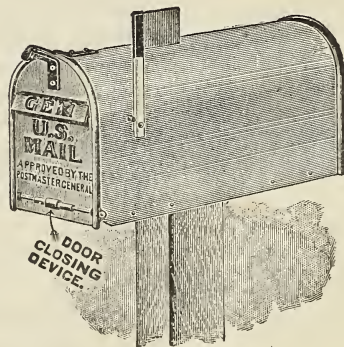

inside letter and penny holder; has a drop-letter hole in door; has substantial steel padlock-hasp; words "U. S. Mail" and "Approved by Postmaster General" are embossed in door and will remain as long as the box lasts; finished in weather-proof bronze; fully one inch taller than most boxes of this style .....\$1.75

### CANAL BARROWS

Bolted Woodwheel 3.25  
Bolted Steel wheel 3.75

## Improved NEW CENTURY

Steel Tray and Steel Wheel

## WHEELBARROW

Weight 42 lbs.

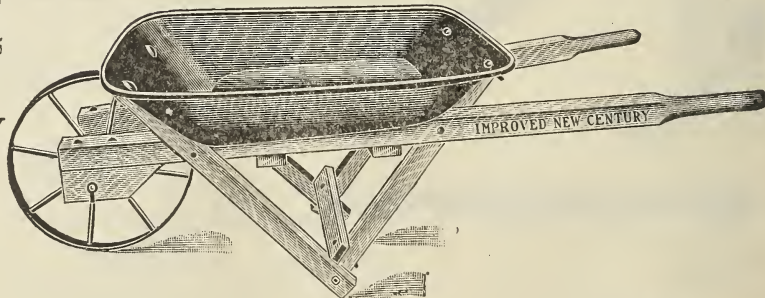

A First-Class, well-made steel wheel Wheelbarrow, with ¼ inch steel rod rolled in edges of tray. Wood frame made of well-seasoned lumber, well bolted together, also to tray. While the tray of this Barrow is a trifle lighter than our regular steel tray Barrow, it is good strong Barrow, and sold at a reasonable price, not very much more than a common wooden canal barrow. **TRY THEM.**

PRICE \$5.98



**OHIO SPIKE TOOTH HARROW - 60 Teeth**

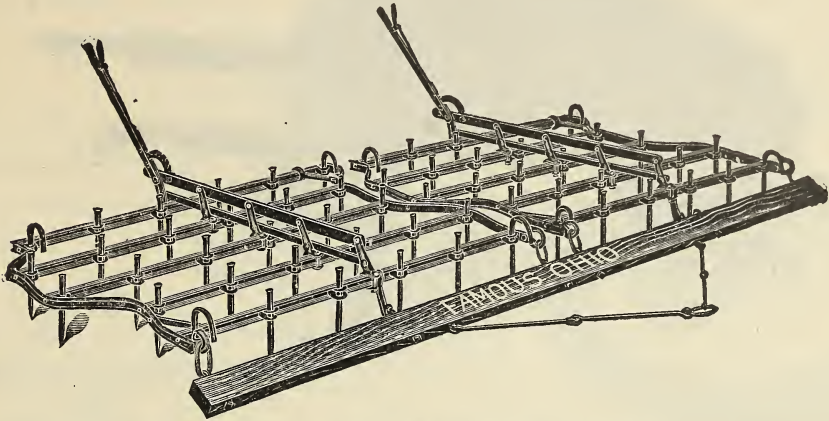

The U-bars, channels, oscillating bars and teeth, are made of high carbon steel, precluding all possibility of bending. The channels, being placed at the ends of the U-bars, prevent them from catching on obstructions as is frequently the case with the open end harrow. Strong and well made but carrying no superfluous weight. Corner braces, oscillating castings and lever castings of malleable iron. Made in one 30 tooth section, and with  $\frac{5}{8}$  teeth, \$16.00, or in Two 30 tooth sections with  $\frac{5}{8}$  teeth, \$30.00.

**THE "ACME" DISC HARROW**

The "ACME" Disc Harrow is a worthy new member of the famous "ACME" Tillage Line. It combines the best features of standard disc harrow construction with exclusive new features that lighten the draft and improve the quality of work performed. Note the offset gangs; they entirely do away with the middle ridge or "comb." Every inch of surface is cut over. The discs are of special shape, giving increased pulverization and a lighter draft. The end thrust on the gangs is received on ball bearings.

10 Disc-16 Dia.-5 feet.....\$59.00

**ACME PULVERIZING HARROW**

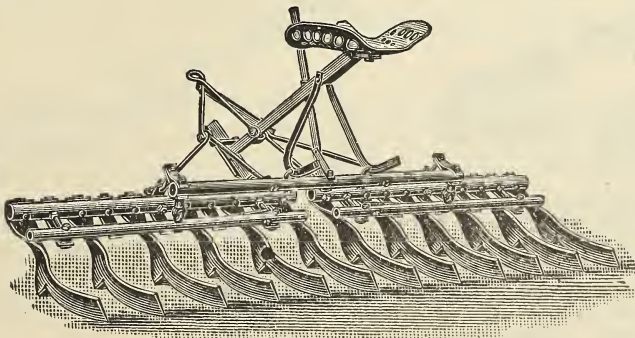

2 Horse .....\$35.00  
 1 Horse .....\$23.00

## DUTCHESS BOLTED GARDEN BARROW

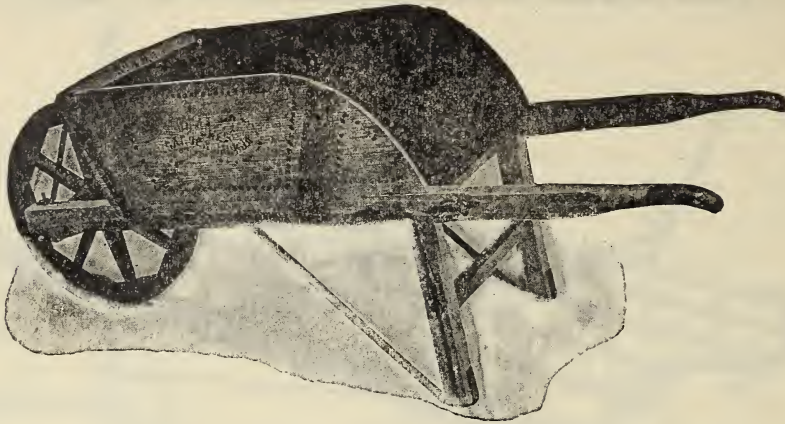

	Wood Wheel	Steel Wheel
No. 2 B. ....	<del>\$4.00</del>	<del></del>
No. 3 C. Medium size.....	<del>4.98</del>	<del>5.48</del>
No. 4 D. Large size.....	<del>5.50</del>	<del>5.98</del>
No. 5 E. Extra Large.....	<del>6.48</del>	<del>6.98</del>

## DUNHAM ROLLER BEARING LAWN ROLLER

Water Filled

Length and Weight precisely as listed

Rollers are smooth on face and aluminum finish, outer edges rounded to avoid cutting up the lawn.

Diameter Length

No.	Inches	Inches	Sections	Pounds	Price
W. B. 3	14	20	1	160	\$17.00
W. B. 5	18	24	1	300	20 00
W. B. 7	24	24	1	500	27.00

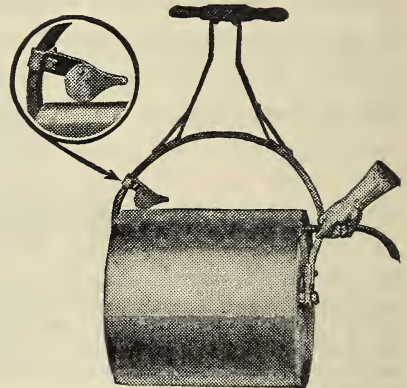

## With The Schoener Garden Tools You Can

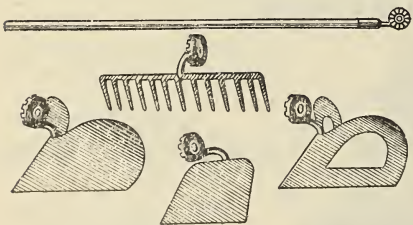

RAKE,  
HOE,  
PLOW,  
CULTIVATE,  
LIST.  
PULVERIZE,  
MAKE SEED BEDS,  
COVER FURROWS

With one strong handle and our three different hoe blades, and the adjustable all-purpose rake, you have a simple, practical garden tool for every need, which can be instantly changed for quickest and best results for the kind of work you have to do. And best of all, no more agonizing backaches, because you can always work in the natural standing position.

By means of the Schoener patented adjustable socket the hoe blades and the rake can be quickly and firmly set at any angle desired: You can attach any of the four tools to the same handle in a few seconds. That is convenience and economy.

Until you actually use the Schoener Handy Garden Tools, you can't realize how much more easily your work is done by being able to set the blades in any position.

Price, \$3.75

**CATTLE CONTENT.** It is a thorough disinfectant and germicide. Protects horses and cows from the torture of flies. The **Lightning Insect Exterminator No. 1** discharges the preparation in a fine, broad spray, without waste and using but very little. Fifty cows can be sprayed in a few minutes. Price.....\$1.50 per gallon

**ARSENATE OF LEAD FOR**

Paste

Its great advantages are that it adheres well to the foliage and spraying does not have to be repeated, as it does not readily wash off by rain. 1 lb., 40c.

Dry

1 lb..... 55c.

**PLANTLIFE.** The Best Insecticide on the Market. Destroys Mealy Bug, Brown and Green Scale, Black and Green Fly Thrips, Red Spider, etc. 1 lb. 20c.

**BLACK-LEAF 40.** A concentrated solution of nicotine sulphate; an excellent spray for black aphides and sucking insects of all kinds. Dilutes one part to 900 or 1,000 parts of water, according to treatment. Full directions on each package, 1-oz. bottle 25 cts., ½-lb. tin \$1.00., 2 lbs. \$3.25, 10 lbs. \$13.75.

**BORDEAUX—ARSENATE OF LEAD.** A combination in proper proportions of the standard insecticide and fungicide remedies, thus killing insects and eliminating fungus plant diseases at one spraying and accomplishing the objects in half the time required to spray on separately. Paste, 1 lb., 40c.; 5 lb., 35c.; 10 lb. 28.

**BORDEAUX MIXTURE OR FUNGIROID—**For all fungous diseases, such as mildew and the various rots of the grade. Full directions on label. Paste, 1 lb., 35c; 5 lbs., 30c; 10 lbs., 25c. Dry, 1 lb., 45c; 5 lbs., 40c; 10 lbs., 35c.

**PYROX.** The best and safest all-round spray for all insects, blights and fungus troubles. Kills Potato bugs. Sticks likepaint. 1 lb., 45c; 5 lbs., \$1.75; 10 lbs., \$3.00; 25 lbs., \$6.25.

**ROSE NICOTINE—**Insect and Parasite Destroyer for Insects, Lice on Flowers, Plants, Fruits, Trees, Vegetables, Human Body, Dogs, Cats, Fowls, Earth Worms, Ants, also any House Bug or Vermin. 20c. lb.

**CUT WORM FOOD—**It is simple and easy to use. It consists of a material that is more delicious and is much more preferred by the CUTWORM than the plants themselves. It is sprinkled on the ground around the plant just as it is found in the package. Price 35c.

**TREE TANGLEFOOT.** A paste preparation for painting around the trunk of trees, in the form of a band. Caterpillars and other crawling pests cannot go over it. Lb., 50c; 3 lb. can, \$1.50.

**WEEDICIDE—**Kills grass and weeds of every kind on roadways, gutters, tennis courts, etc., by one application. Price, 50c. qt.; \$1.50 gal.

**GRAFTING WAX.** A wax manufactured specially for grafting trees, bushes, shrubs, etc. ¼ pkg., 15c; ½lb. pkg., 25c; 1 lb. pkg., 40c.

**Sulphur, Powdered—**A remedy for insects of all kinds, both by itself and in combination with other remedies. 1 lb., 15c; 5 lbs., 10—Special Price bbl. Lots.



**Hammond's Slug Shot—**An insecticide for the destruction of Potato and Rose bugs, and all Lice, Worms or caterpillars upon Melons, Egg, Cucumber, Cotton, Tobacco and Cabbage plants,, Tomato Currants, Fruit or Ornamental Trees, Grape Vines, Shrubs and Flowering plants, 1 lb. 15c; 5 lb. pkg., 45 c.

**Strictly Pure Paris Green—**Market Price.

**Double Ground Land Plaster—**Per 100 lb. bag 90c—\$15 00 Ton Sulpho Tobacco Soap 10c. & 20c.

## THE AUTO No. 40 WHEEL SPRAYER

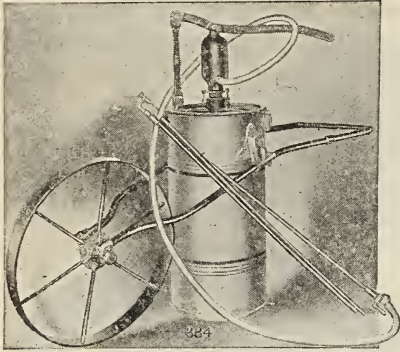

Applies, in a mist-like spray, all fluid insecticide and fungicide solutions on garden crops, ornamental plants, shrubs and low trees; also useful for whitewashing, applying sheep dip, fly oils, etc. It is a most convenient, large capacity Auto Sprayer, fitted to a tubular iron frame with 20-inch wheel, so that it is as easily moved about as a wheel-barrow. The tank of heavy galvanized steel or brass (as may be selected) holds the spray solution and the compressed air pump with which the operator keeps up a continuous and uniform spray. The machine is furnished with 8 ft. of high pressure spray hose with connections in 8 ft. iron extension pipe with lever "shut-off" for tree spraying and the latest pattern Vermorel nozzle, which fits either the hose or pipe. Price, with 12 gal. galvanized steel tank. \$25.00, without wheels \$20.00.

## LOWELL GRAND SPRAYER FOR LIQUID

### DESCRIPTION.

Tapered cylinder reservoir, 4 inch bottom, 3 inch top, 1½ inch pump cylinder, 20 inches long. Plunger rod bright steel. Plunger our special make. Two brass solution or spray tubes. One inch zinc can screw for filling. Strong and durable in construction. Each sprayer is tested for leaks and perfect spray. Capacity of tank one quart. Aluminum finish. Galvanized Steel, 75c.

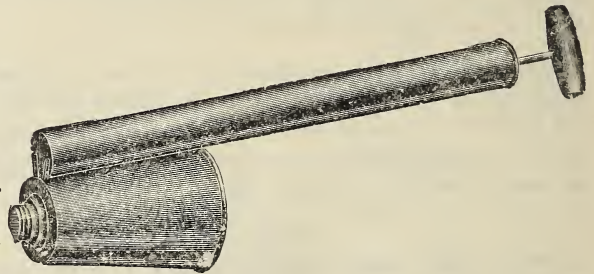

Lowell Baby Midget Sprayers for Liquids, 35c.

## BROWN'S CONTINUOUS SPRAYER

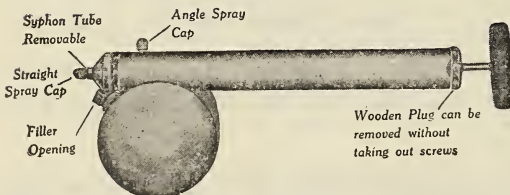

The Brown Continuous Sprayer, as the name implies is so constructed that it not only sprays on the downward stroke of plunger but also when it is drawn back, thus causing a continuous mist-like spray.

Brass Lacquered, \$1.25.

## THE LOWELL FOUNTAIN COMPRESSED AIR SPRAYER

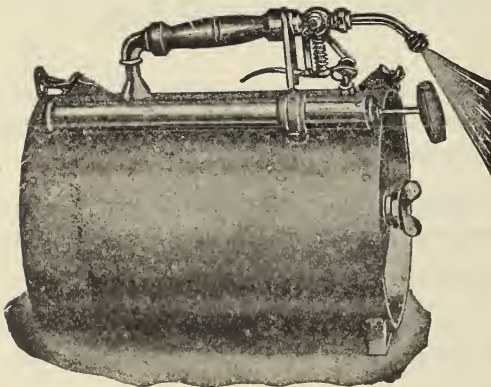

One pumping will expel entire contents of tank and is sufficient to spray 2,000 plants. Spraying nozzle may be reversed to spray under side of bushes and plants. Automatic Thumb Lever Valve it at all times under complete control of operator, hence none of the solution is wasted. It saves its cost in making a given amount of compound do so much more work. An Adjustable Shoulder Strap and Tree Attachment with suitable coupling for orchard and tree spraying, furnished with each machine. Aluminum finish. Capacity, 3 gallons. Price, Galvanized, \$6.48; Brass, \$9.48.

## “LIGHTNING” WHITEWASH SPRAYER

This is the only Spray Pump that will properly spray whitewash without clogging. It is constructed of heavy galvanized iron, with brass tops and valves. Large air chambers and ball valves, the pressure maintaining a continuous stream or spray not affected by the upward stroke. Can also be used for washing windows, buggies and sprinkling lawns, flowers, etc.

Galvanized Iron, \$2.98; Brass, \$4.25.

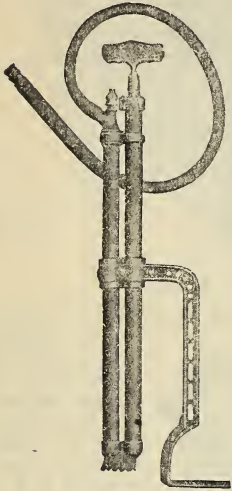

**AUTO SPRAY NO. 2.**  
All Brass Whitewash General Purpose Sprayer.  
Price, \$4.48.

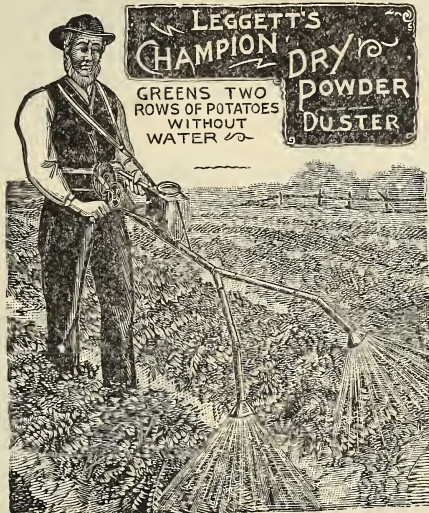

Price, \$15.00

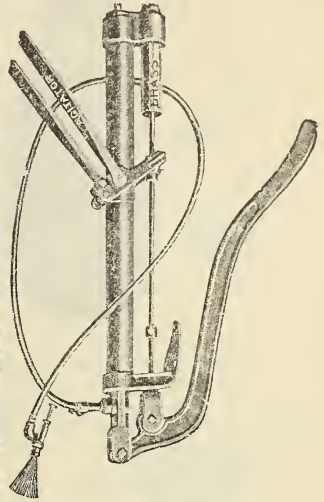

**PUMP NO. 25 FOR BARREL USE**  
PRICE, \$14.98

## BROWNS AUTO SPRAY NO. 1



The Auto-Spray No. 1 is the standard of all compressed air sprayers. It is the strongest and most simple in its working parts of any similar machine. Self operating. Two pumpings of a few strokes on the plunger will discharge the contents under high and constant pressure. After pumping, the operator has only to direct the spray.

**Uses.** For spraying trees, shrubs, vines, field crops, in the greenhouse, poultry house. For applying disinfectants and cattle-fly oils. Will handle all solutions, including whitewash and cold water paint.

Price, Galvanized, \$6.98.

Brass, \$9.98



## Measuring Rods.

FOR MILK CANS

- Metal .....75c
- Wood .....75c

Dairy Thermometers, 25c each.

- Lactometers, approved by the N. Y. Board of Health to test the quality of Milk, 75cts. each
- Long Handle Measure for Milk Cans.

**DAIRY and MILKMEN SUPPLIES**

**MILK BOTTLES**

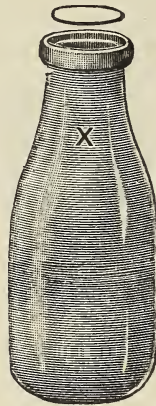

No. 2 Common Sense

1 qt., doz.	\$1.00	Gross	\$9.00
1 pt., doz.	.90	Gross	\$8.00
½ pt., doz.	.80	Gross	\$7.00

In 10 gross lots we furnish the plate free.

**Milk Bottle Carriers**

**TINNED WIRE**

6 1 pt. bottles, .98c; 6 1 qt. bottles, \$1.25; 3 1 qt. bottles, \$1.50; Galvanized iron wire, 6 qt. flat wire, \$1.25; Heavy flat wire, \$1.75; 8 qt., \$2.00.

**Dairy Men's Cleaner and Cleanser for Milk Bottles**

It is also a perfect sanitary cleanser for use in the home or on the farm, for washing dishes, glass, refrigerators, pots and pans, milking utensils, floors, baths, toilets, etc. 5 lb. .35

**MILK STRAINERS, 25c and up.**

**Milk Bottle Filler.**

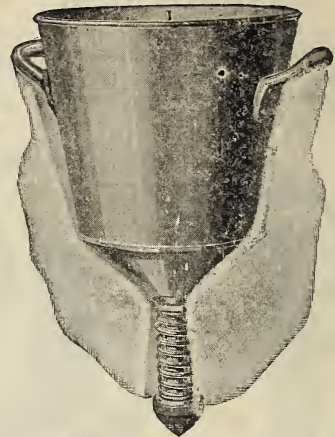

Works Easily and Quickly.  
Guaranteed \$11.48

**MILK BOTTLE FILLERS.**

Sensible ..... \$10.98

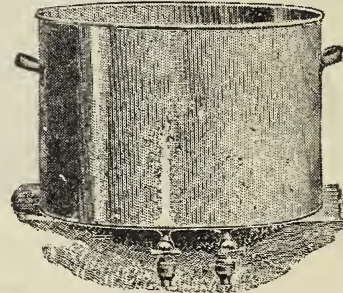

It is sensible because it is simple, no levers, no springs, just a heavy tin tank made of I X X X X C o o k l e y K Charcoal tin plates, lolding 60 quarts, and with two faucets in the bottom. These

remove any particles which may have remained in the milk, and cause the streams to flow in smooth, even columns.

We have built the Sensible so strong and heavy that it will last a life time. You can find no more sensible way to fill your bottles. Price, \$6.50

**Milk Pails**



One quart to twenty quarts

DAIRY AND MILKMEN SUPPLIES Continued

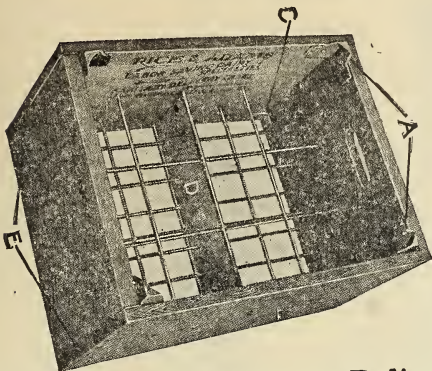

**R. & A. Unbound Sanitary Delivery Cases.**

Patented Nov. 7, 1905

The weight of unbound cases is about three pounds less than bound cases, and for this reason they are preferred by many dealers. This style is made with or without bottom corner irons. Pressed galvanized steel stacking corner irons are always included.

- A-Heavy stacking corner iron.
- C-Bottom corner iron.
- D-galvanized steel support.

The bottles are always held in correct position to be filled and capped, as the galvanized steel support "D" keeps the long wires from sagging.

- 1 qt. size (12 bottles)... \$1.75
- 1 qt. size (Iron stripped)... \$1.90

**The Blanchard Churn**

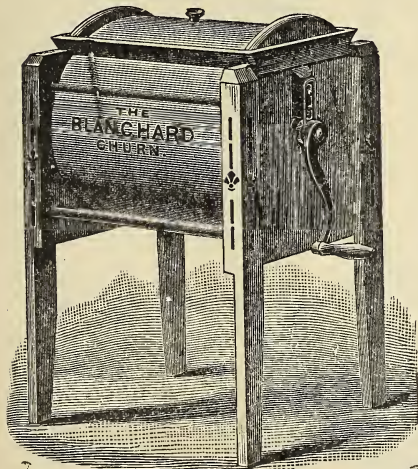

Price List Family Sizes

No.	Will Hold	Price
3	2 gals.....	\$ 8.50
4	4 gals.....	10.00
5	8 gals.....	12.00
6	12 gals.....	15.00
7	16 gals.....	18.00



**MILK CAPS.**

- New Seamless Pull Cap.
- Heavy Waxed, Printed.
- Heavy Waxed, with lip, Printed.
- New Lip Cap, lip will not pull off.

Prices on Application.

Name and address printed free on lots, 50 M.

**Milk Cans**

- 20 qts., \$6.50; 30 qts., \$7.50; 40 qts., \$8.00.

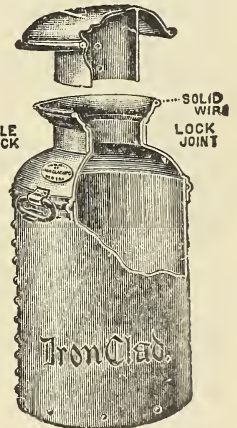

**The Cylinder Churn**

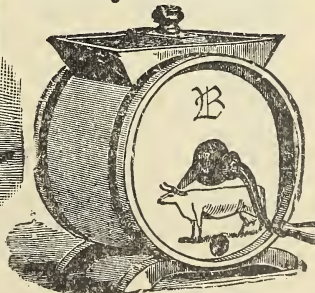

No. 0	\$3.75
No. 1	4.25
No. 2	4.75
No. 3	5.50
No. 4	6.50

**The Lightning Churn**



No.	Will Hold	Price
0	½ gals.....	\$5.00
1	2½ gals.....	5.75
2	3½ gals.....	6.50
3	4½ gals.....	7.50

# INDEX

Page	Page
Apple and Grape Grinders..... 67	Grit and Shell Box.....43
Artichoke ..... 5	Grape Worm Extractor.....44
Asparagus ..... 5	Grass Hook ..... 66
Asparagus Bunches ..... 67	Grindstone ..... 68
Barrows .....69, 70	Grass Seeds .....33, 34
Barley .....36	Garden Syringe ..... 66
Beans .....6, 7	Herbs .....31
Beets .....7, 8	House Paint.....50
Borage ..... 8	Hygrometer Incubator.....44
Broccoli ..... 8	Hovers .....40
Brussels Sprouts ..... 9	Hoppers Sexton.....50
Brooders .....40	Hand Mills.....51
Bone Cutters .....51	Harrows .....67, 68, 69
Buckwheat .....36	Hoes .....58, 59, 60, 63
Cabbage ..... 9	Weeding ..... 63
Carrots ..... 10	Onion ..... 63
Cauliflower .....10, 11	Field ..... 63
Celery ..... 11	Potato Hooks ..... 63
Celериac ..... 11	Incubators .....40
Chervil ..... 11	Insecticides for Plant Diseases.....54
Chicory .....12, 15	Lemon Oil.....54
Cress ..... 12	White Hellebore.....54
Corn Salad ..... 12	Whale Oil Soap.....54
Corn .....12, 13	Scalecide ..... 71
Cucumbers ..... 14	Slug Shot ..... 71
Caponizing Sets.....44	Paris Green ..... 71
Clover .....34	Bordeaux Mixture ..... 71
Chick Server .....45	Kale .....3, 16
Chick Marker.....44	Kohlrabe ..... 16
Cider Mills.....67	Leek ..... 17
Cultivators .....58, 59, 60, 61	Lettuce .....2, 17, 18
Churns .....50, 75	Leg Bands.....48
Dandelion .....15	Lawn Mowers.....64, 65
Dairy & Milkman's Supplies.74, 75	" Rollers .....65, 70
Dog Cakes .....54	" Trimmer ..... 65
Endive ..... 15	" Grass .....31, 32
Egg Plant ..... 15	" Dressing ..... 31
Egg Tester .....48	Lamps, Incubator.....44
Folding .....46	Lightning Butter Feeder.....50
Egg Carriers.....47	Limestone .....38, 39
Egg Cases.....47	Melon, Musk ..... 19
Egg Boxes.....47	" Water .....19, 20
Feeders, Poultry.....45	Mushrooms ..... 20
Ideal Automatic .....48	Mustard ..... 20
Dry (Egg) Mash.....43	Milk Caps ..... 75
Fence and Drinking Cups.....48	" Bottle Carriers .....74
Fence .....42, 61	" Bottle Cleanser .....74
Flower Bed Guard.....42	" Bottle Boxes.....75
Flower Stands.....41	" Cans ..... 75
Flower Pots.....41	" Pails ..... 74
Forks .....62, 63	" Bottles ..... 74
Manure .....62, 63	" Can Measuring Rods.....73
Spading ..... 62	Delivery Cases.....75
Hay ..... 62	Mail Boxes ..... 68
Fountains .....46	Markers ..... 57
Keystone ..... 46	Darnell ..... 57
Norwich Automatic.....47	Eddy ..... 57
Sanitary .....46	Meadow and Pasture Mixture.....34
Brooder .....46	Nasturtium .....21
Wall .....46	Nests .....48
Sexton .....46	Chicken .....48
Earthenware .....46	Pigeon .....48
Fertilizers .....37	Nest Eggs.....49
Muzzy Bros. Special.....37	Netting Wire.....50
Ground Bone .....37	Onion .....21
Nitrate of Soda.....38	Onion Sets .....21
Acid Phosphate .....38	Okra .....22
Garden Guide ..... 4	Oats .....36
Grains .....36	Ornamental Walk Gate.....42
Garden Tools .....58, 60, 70	Parsnips .....22
Gates .....42	Parsley .....22
	Peas .....22, 23
	Pepper .....24
	Philadelphia Mower .....65
	Potatoes .....24, 25
	Pumpkin .....25
	Poultry Punch .....44
	Plows .....55, 56, 58, 59
	Pruning Shears .....66
	Pruning Saws .....66
	Poultry Killing Knife.....44
	Potato Hooks .....63
	Potato Digger.....63
	Poultry Remedies.....53
	Pratts Regulator .....53
	Disinfectant and Lice Killer.....53
	Pratts Roup Remedy.....53
	" Lice Killer.....53
	" Diarroea Remedy.....53
	" Condition Powders.....53
	" Bronchitis Remedy.....53
	" Gape Remedy.....53
	" Sore Head Remedy.....53
	" Scaly Leg Remedy.....51
	Rose nicotene.....54, 71
	Poultry Food .....41, 43
	Chick Starter .....52
	Chick Feed .....43, 52
	Buttermilk Startingfeed.....49, 52
	Developing Food.....52
	Scratch Food.....52
	Beef Scrap.....52
	Laying Food.....43
	Pigeon Feed.....43
	Charcoal .....43
	Ground Bone.....43
	Cut Alfalfa Clover.....43
	Cut Red Clover.....43
	Crushed Oyster Shells.....43
	Crystal Grit.....43
	The Collins Sprouter.....45
	Foust's Health Grit.....43
	Rhubarb .....25
	Radish .....26
	Roofing .....51
	Roofing Paper .....51
	Rakes .....59, 66
	Rat Cure.....54
	Spinach .....26, 27
	Salsify .....27
	Squash .....4, 27, 28
	Swiss Chard .....28
	Seed Drills.....58, 59
	Seeds, Miscellaneous.....36
	Sprayers .....72, 73
	Powder .....72
	Liquid .....72
	Continuous .....72
	Compressed Air .....72
	Auto Spray .....73
	Whitewash .....49, 73
	Sweet Pot and Medical Herb
	Seeds .....30
	Scythes .....66
	Tobacco .....28
	Tomato .....3, 28, 29
	Turnip .....29, 30
	Tree Guards.....67
	Thermometer, Incubator.....44
	Wheat .....36
	Weeders .....67
	Zenoleum .....54



# Foreign Names of Vegetables and Herbs

ENGLISH	GERMAN	FRENCH	ITALIAN	HOLLAND
Anise.....	Anis, Grvener ...	Anis .....	Anaso, Anacio ...	Anijs .....
Artichoke.....	Arrischocke .....	Artichaut .....	Articozza .....	Artisjok .....
Asparagus.....	Spargel .....	Asperge .....	Sparagio .....	Aspersie .....
Balm .....	Citronen Melisse..	Melisse citronelle.	Melissa .....	Citroen Mellisse ..
Basil .....	Basilikum .....	Basilic grand .....	Basilico .....	
Beans .....	Bohnen .....	Haricots .....	Fagioli .....	Boonen .....
Beet .....	Ruebe .....	Betterave .....	Barbabetola .....	Bieten .....
Borage .....	Boretsch .....	Bourrache .....	Boragine .....	
Broccoli .....	Spargelkohl .....	Chou Brocoli .....	Cavol brocolo ...	Spruitkool .....
Brussels Sprouts .	Roseukohl .....	Chou de Bruxelles	Cavolo agermaglia	Slutkool .....
Cabbage .....	Kopfkohl, Kra .....	Chou pomme .....	Cavolo cappuccino.	Savooikool .....
Cabbage Savoy ..	Wirsing .....	Chou de Milan .....	Cavolo di Milano.	Karvij .....
Caraway .....	Feld Kuemmel .....	Chum des press..	Carvi .....	Wortelen .....
Carrot .....	Carroten, Moehren	Carotte .....	Carato .....	Bloemkool .....
Cauliflower .....	Blummenkohl .....	Chou-fleur .....	Covolo-flore .....	Seiderij .....
Celery .....	Sellerie .....	Clerie .....	Sedano .....	Knolse erji .....
Celeriac .....	Knoll-Sellerie .....	Celere-rave .....	Se ana rapa .....	Kervil .....
Chervil .....	Kerbet .....	Cerfeuil .....	Cerfoglio .....	
Chicory .....	Chicorieen wurzel.	Chicoree sauvage.	Cicoria Wselvatca	Korlander .....
Coriander .....	Coriander .....	Corlande .....	Coriandorio .....	Veslesia .....
Corn Salad .....	Feldsalat .....	Mache .....	Valeriana .....	
Corn .....	Mais .....	Mais .....		Tunkers .....
Cress .....	Garen Kresse .....	Cressen aenois .....	Agretto .....	Waterkers .....
Cress, Water .....	Brunnen Kresse .....	Cressoudefontaine	Nasturzio .....	Komkomer .....
Cucumber .....	Gurken .....	Concombre .....	Cotriolo .....	
Dandelion .....	Loewenzohle .....	Pissenlit .....	Dente di leone .....	
Dill .....	Dille .....	Aneth .....	Aheto .....	
Egg Plant .....	Eier Fflano .....	Aubergine .....	Pentonciano .....	Andijve .....
Endive .....	Endiven .....	Cicorce-Endive .....	Indivia .....	Nedkel .....
Fennel .....	Fenchel .....	Fenouil .....	Finnochlo .....	Knoflook .....
Garlick .....	Knoblauch .....	All .....	Agho .....	Peperwortel .....
Horse Radish .....	Meer Rettig .....	Panifort sauvage.	Rafano .....	Hijsoop .....
Eyssop .....	Isop .....	Hyssope .....	Issopo .....	Boerkool .....
Kale .....	Blaetterkohl .....	Chou-vert .....	Cavolo verde .....	Koolrabi .....
Kohlrabi .....	Knolkohl .....	Chou-rave .....	Cavolo rapa .....	
Lavender .....	Lavendei .....	Lavende .....	Lavada .....	
Leek .....	Porre Lauch .....	Poireau .....	Porro .....	Prei .....
Lettuce .....	Lattich Kopsalat	Laitue .....	Lattuga .....	Kropsla .....
Marjoram .....	Marjoram .....	Marjolaine .....	Maggiorana .....	Marjoliijn .....
Melon .....	Melone .....	Melon .....	Popone .....	Meleon .....
Melon, Water .....	Wasser-Melone .....	Melon d'eau .....	Cocomera .....	Kampernoelle ...
Mushroom .....	Schwamm .....	Champignon .....	Fungo pratajole	Camucine-kers ..
Nasturtium .....	Kupuciner Kresse.	Capucine .....	Nasturzio .....	
Okra .....	Ocher .....	Gombeud .....	Ibisco .....	
Onion .....	Zwiebel .....	Ognon .....	Cipollo .....	Ci Ulen .....
Parsley .....	Zatersille .....	Persil .....	Prezzemolo .....	Peterselit .....
Parsnip .....	Pastinake .....	Panals .....	Pastinaca .....	
Peas .....	Erbsen .....	Pois .....	Pisello .....	Pinksternadel ...
Pepper .....	Pfeffer .....	Piment .....	Peperone .....	Erwten .....
Pumpkin .....	Melonen-Kuerbiss	Potiron .....	Zucca .....	Spaansch Peper ..
Radish .....	Radies .....	Rdis .....	Ravanello .....	radijs .....
Rhubarb .....	Rhubarber .....	Rhubarbe .....	Rabarbaro .....	tabarber .....
Rosemary .....	Rosmarin .....	Romarin .....	Rosmorino .....	Rosemarijn .....
Rue .....	Raute .....	Rue .....		Wijnaut .....
Saffron .....	Safran .....	Safran .....	Rafferano .....	
Sage .....	Saidel .....	Sauge .....	Salva .....	Salie .....
Salsify .....	Haferwurzlel .....	Salrifis .....	Barbarli becca ..	
Sorrel .....	Sauerampfer .....	Oscille .....	Aetososa .....	Zuring .....
Summer Savory ..	Bohenkraut .....	Sarriette annulle.	Santoreggia .....	Boonenkruid .....
Spinach .....	Spinat .....	Epinarde .....	Spinnaccio .....	Spinazie .....
Squash .....	Kuerbijs .....	Courgel .....	Zucca .....	Pompeon .....
Tansy .....	Gemelner-rainfarn	Tanaisle .....	Atansia .....	
Thyme .....	Thymian .....	Thym .....	luno .....	Tijn .....
Tomato .....	Liebessapfel .....	Pomme d'Amour ..	Pomo d'oro .....	lonaat .....
Turnip .....	Weisse-Reube .....	Nevet .....	Navone .....	kapen .....
Wormwood .....	Wermuth .....	Absinthe .....	Assenzio .....	Sukerij .....

## PLANTING CALENDAR

**FEBRUARY**—Sow in Hot Bed. Early Beans, Cabbage, Cauliflower and Celery, Carrot, Brocoli Cucumber, Lettuce, Parsley, Radish, Tomato.

**MARCH**—Sow in Hot Bed. Early Beets, Beans, Cabbage and Carrots, Brocoli, Brussels Sprouts, Cauliflower, Celery, Cucumber, Egg Plant, Kohlrabi, Lettuce, Melon, Parsley, Peas, Pepper, Radish, Aomato. Plant in Open Ground. Beet, Early Cabbage, Carrot, Cress, Lettuce, Onion, Peas, Radish, Round Spinach, Early Turnip, Potatoes. Onion Sets, English Bean.

**APRIL**—Sow in Hot Bed. Sweet Corn, Cucumber, Egg Plant, Melon, Pepper, Squash, Tomato. Plant in Open Ground. Asparagus, Beets, Brocoli, Brussels Sprouts, Early Cabbage, Carrot, Cauliflower, Celery, Cress, Kale, Kohlrabi, Lettuce, Melon, Onion, Parsley, Peas, Radish, Round Spinach, Turnip, Sage, Potatoes, Top Onions.

**MAY**—Plant in Open Ground. Asparagus, Beans, Beets, Brocoli, Brussels Sprouts, Late Cabbage, Carrot, Cauliflower, Celery, Sweet Corn, Cress Cucumber, Kale, Lettuce, Melon, Okra, Onion Parsley, Parsnip, Peas, Potatoes, Radish, Rhubarb, Kohlrabi, Salsify, Round Spinach, Squash, Tomato, Early Turnip, Herbs.

**JUNE**—Plant in Open Ground. Lima Beans, Beets, Brocoli, Brussels Sprouts, Cabbage, Carrot, Sweet Corn, Cress, Cucumber, Kale, Kohlrabi, Lettuce, Nasturtium, Okra, Peas, Potatoes, Parsnip, Radish, Salsify, Spinach, Squash, Ruta, Baga, Melon, Herbs.

**JULY**—Plant in Open Ground. Beans, Beets, Cauliflower, Celery, Carr. t, Sweet Corn, Cress, Cucumber, Late Cabbage, Kale, Kohlrabi, Nasturtium, Okra, Peas, Parsnip, Winter Radish, Spinach, Ruta Baga.

**AUGUST**—Plant in Open Ground. Bush Beans. Late Celery. Late Cabbage. Cucumber, Lettuce. Peas, Radish, Spinach, Turnip.

**SEPTEMBER**—Plant in Open Ground. Cabbage, Cauliflower and Lettuce for wintering in cold frames. Asparagus, Celery, Kale, Mustard, Winter Radish, Spinach, Turnip

